

PE5108

15A/10A 8-Outlet 1U Metered eco PDU



- 1U 8-Outlet eco PDU
- Bank level metering

ATEN has developed a new generation of green energy power distribution units (PDUs) to effectively increase the efficiency of data center power usage. The PE5108 eco PDUs are intelligent PDUs that contain 8 AC outlets and are available in various IEC or NEMA socket configurations. They provide secure, centralized, intelligent, power management of data center IT equipment (servers, storage systems, KVM switches, network devices, serial data devices, etc.), as well as the ability to monitor the center's health environment via sensors*.

eco PDUs offer real-time power measurement - allowing you to monitor the power status of devices attached to the PDUs, from practically any location via a TCP/IP connection.

eco PDU supports any 3rd party v3 SNMP Manager Software and [eco DC](#) (Energy Management Web GUI). [eco DC](#) provides you with an easy method for managing multiple devices, offering an intuitive and user friendly Graphical User Interface that allows you to configure a PDU device and monitor power status of the equipment connected to it. With [eco DC](#), the Sensor-enabled eco PDU also offers comprehensive power analysis reports which can separate by departments and locations, providing precise measurements of current, voltage, power and watt-hour in a real-time display.

With its advanced security features and ease of operation, the eco PDU is the most convenient, most reliable, and most cost effective way to remotely manage power access for multiple computer installations and allocate power resources in the most efficient way possible.

Note: Sensors are optional accessories. A sensor-enabled installation is required to generate a more complete energy-efficient data and chart. Higher sensor installation density is helpful to generate more accurate data.

Features

- **Connections**
 - Support 10/100Mbit Ethernet Interface
 - Support TCP/IP, UDP, HTTP, HTTPS, SSL, DHCP, SMTP, NTP, DNS, Auto Sense, Ping, Telnet, and SNMP V1,V2&V3
 - Support 2-level account/password security, IP/MAC filter, 128 bit SSL, RADIUS
 - Support : [eco DC](#), Browser (IE, Firefox, Chrome, Safari)
- **Metering**
 - Bank level power metering and monitoring
 - Environment Monitoring : support external temperature/temperature & humidity sensors for rack temperature and humidity monitoring
 - Current, voltage, power, power dissipation, temperature, and humidity metering and threshold level setting
- **Features available only on firmware-upgraded models with -ATB part number**
 - Supports SMPTS, IPv6, Modbus (Over TCP/IP), Auto Ping, TLS1.2, SSH
 - Supports IEEE 802.1X
 - Authentication: LDAP, TACACS+
 - UI – heartbeat, schedule control, mail control, and setting rule

Specification

Function	PE5108A	PE5108B	PE5108G
Electrical			
Nominal Input Voltage	100 – 120 VAC	100 – 240 VAC	100 – 240 VAC
Maximum Input Current	15A Max; 12A(UL de-rated)	15A Max; 12A(UL de-rated)	10A Max
Input Frequency	50-60 Hz	50-60 Hz	50-60 Hz
Input Connection	NEMA 5-15P	NEMA 6-15P	IEC 60320 C14
Input Power	1800 VA(Max); 1440 VA(UL de-rated)	3120 VA(Max); 2496 VA(UL de-rated)	2300 VA(Max)
Outlet Type	Total: 8 x NEMA 5-15R	Total: 8 x IEC320 C13	Total: 8 x IEC320 C13
Nominal Output Voltage	100 – 120 VAC	100 – 240 VAC	100 – 240 VAC
Maximum Output Current (Outlet)	NEMA 5-15R: 15A(Max); 12A(UL de-rated)	C13 : 15A(Max); 12A(UL de-rated)	C13 : 10A(Max)
Maximum Output Current (Bank)	15A(Max); 12A(UL de-rated)	15A(Max); 12A(UL de-rated)	10A(Max)
Maximum Output Current (Total)	15A(Max); 12A(UL de-rated)	15A(Max); 12A(UL de-rated)	10A(Max)
Breakers	1 x 15A Non-Fuse Breaker	1 x 15A Non-Fuse Breaker	1 x 10A Non-Fuse Breaker
Metering	Bank level Current, Voltage, VA , PF and KWh Monitoring	Bank level Current, Voltage, VA , PF and KWh Monitoring	Bank level Current, Voltage, VA , PF and KWh Monitoring
Outlet Switching	None	None	None
Environment Sensor Ports	2	2	2
Metering Accuracy	Voltage Range: 100VAC ~ 250VAC +/-1% Power Range: 100W ~ Maximum Capacity +/- 2% Current Range: 0.1A~1A +/- 0.1A, 1A~20A +/- 1%	Voltage Range: 100VAC ~ 250VAC +/-1% Power Range: 100W ~ Maximum Capacity +/- 2% Current Range: 0.1A~1A +/- 0.1A, 1A~20A +/- 1%	Voltage Range: 100VAC ~ 250VAC +/-1% Power Range: 100W ~ Maximum Capacity +/- 2% Current Range: 0.1A~1A +/- 0.1A, 1A~20A +/- 1%
Physical Properties			
Dimensions (L x W x H)	43.24 x 4.40 x 21.93 cm	43.24 x 4.40 x 21.93 cm	43.24 x 4.40 x 21.93 cm
Weight	2.77 kg	2.82 kg	2.82 kg
Power Cord Length	3 m	3 m	3 m
Environmental			
Temperature (Operating / Storage)	0 – 50°C / -20 – 60°C	0 – 50°C / -20 – 60°C	0 – 50°C / -20 – 60°C
Humidity (Operating & Storage)	0 – 80% RH, Non-Condensing	0 – 80% RH, Non-Condensing	0 – 80% RH, Non-Condensing
Compliance			
EMC Verification	FCC, Others by Request	FCC, Others by Request	CE, Others by Request
Safety Verification	UL, Others by Request	UL, Others by Request	CE-LVD, Others by Request
Note	For some of rack mount products, please note that the standard physical dimensions of WxDxH are expressed using a LxWxH format.		

Diagram

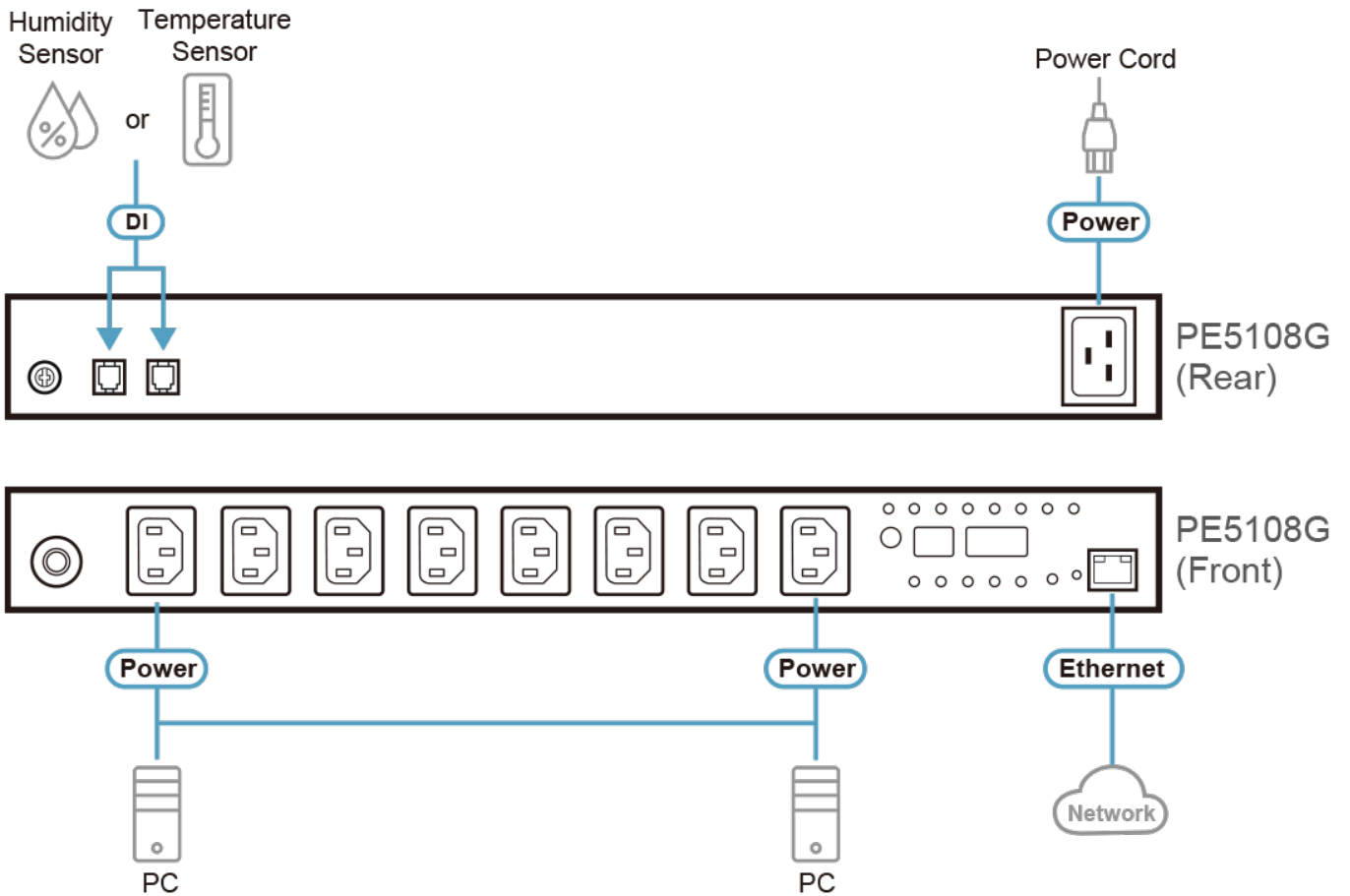

ATEN International Co., Ltd.

3F., No.125, Sec. 2, Datong Rd., Sijhih District., New Taipei City 221, Taiwan
Phone: 886-2-8692-6789 Fax: 886-2-8692-6767
www.aten.com E-mail: marketing@aten.com



© Copyright 2015 ATEN® International Co., Ltd.
ATEN and the ATEN logo are trademarks of ATEN International Co., Ltd.
All rights reserved. All other trademarks are the property of their respective owners.