

UC232A

USB to RS-232 Adapter (35cm)



Stable Transmission, Reliable Connectivity

USB-A to RS-232 Converter 35cm

UC232A



USB-A



RS-232



Anti-EMI



Stable Performance, Fast Transmission

The UC232A is a 35cm one port USB-A to RS-232 adapter, ideal for laptops/PCs without COM or DB-9 port to connect with legacy serial devices. It offers USB 2.0 compliant connectivity and is equipped with robust cables that enhance its anti-EMI capability for faster and more reliable signal transmission. Plus, its plug-and-play feature ensures hassle-free setup and instant usability.



Contact Us

Get a quote for this product or get in touch with our sales experts

Get Quote

[Contact Sales](#)

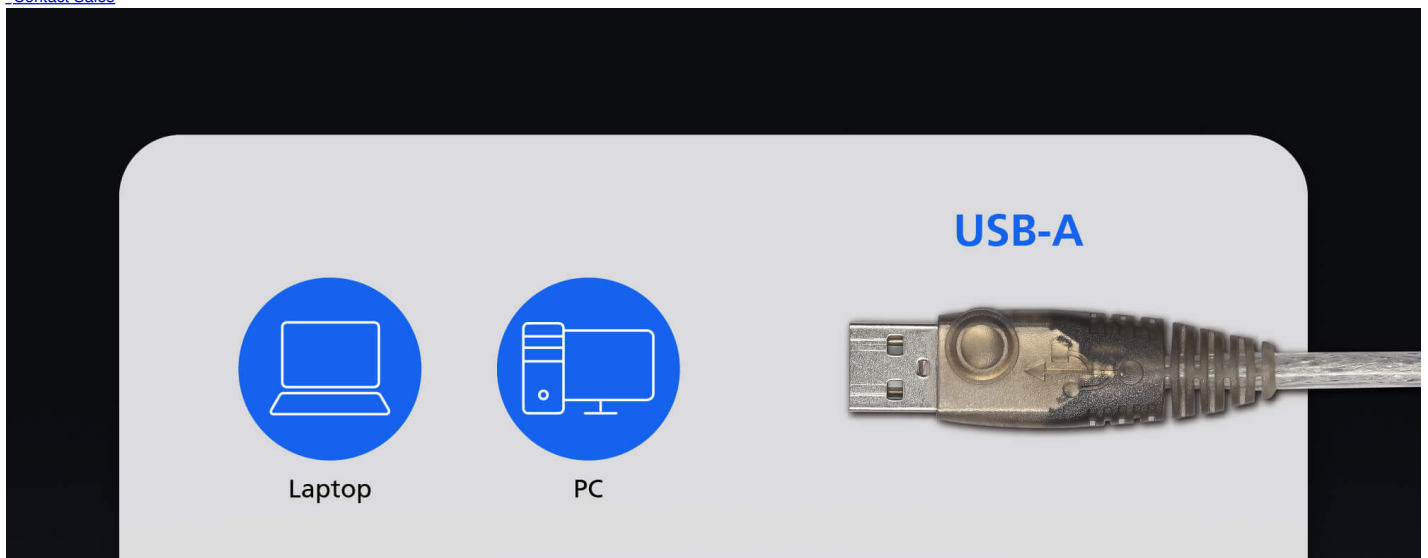

RS-232



Modem

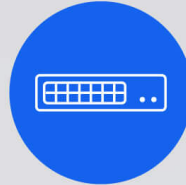

Network Switch

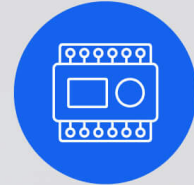

PLC Controller



Printer

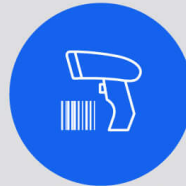

Scanner

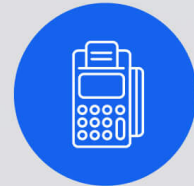

POS

Usage Scenarios



POS Terminal



Barcode Scanner

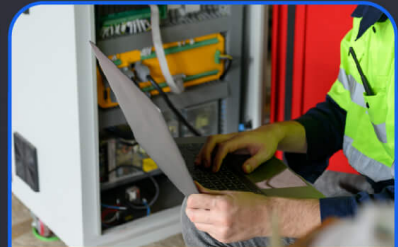

PLC Programming

Wide Range of Applications

UC232A supports Windows, Mac and Linux with data transfer rates up to 921.6 Kbps, it serves as a convenient connectivity solution for PC or laptop controlling and communicating with various serial devices such as modem, network switch, PLC controller, printer, scanner, POS and so on.

Product Comparison

The UC232 lineup is well-suited for a variety of applications including industrial automation, IT networking, and control systems.

*Notes: Models equipped with FTDI chip provide better signal transmission with legacy Windows OS.

Talk to Our Experts

If you prefer to have ATEN contact you, please complete the form and a representative will be in touch with you shortly

Features

The UC232A USB-to-RS232 serial port converter is the ideal accessory for laptop and desktop computers that do not have a COM or DB9 serial port. Supporting both PC and Mac systems with baud rates up to 921.6 Kbps for rapid performance, it offers a convenient connectivity solution for industrial automation systems, scientific instruments, point of sale systems, and other specialized industrial and consumer applications.

The UC232A now supports mobile devices as a computing host (Android 3.2 and above). The UC232A SDK is available for download in the Support and Downloads section. To download the mobile demo app from the Google Play store, please click on or scan this QRCode.



NOTICE

If your Linux kernel is between v2.6.15 ~ v5.4 and your device has a new chipset version, please update the Linux driver

Note: This driver works with 2021 or later chipset version device only.

Use the link below to identify which chipset version your device is

<https://eservice.aten.com/eServiceCx/Common/FAQ/view.do?id=18695>

- Support the RS-232 Serial interface
- Full compliance with the USB Specification
- Up to 921.6 Kbps data transfer rate
- Works with cellular phones, PDAs, digital cameras, modems or ISDN terminal adapter
- OS Compatibility: Windows, Mac, Linux

Specification

Connectors	
USB Port	1 x USB Type A Male (White)
Serial	1 x DB-9 Male (Silver)
Data Rate	Up to 921.6 Kbps
Cable Length	35cm
LEDs	Power (Orange)
Power Mode	Bus Powered
USB Specification	USB compliant
Environmental	
Operating Temperature	0–40°C
Storage Temperature	-20–60°C
Humidity	0–80% RH, Non-condensing
Physical Properties	
Housing	Plastic
Weight	0.04 kg (0.09 lb)
Dimensions (L x W x H)	6.59 x 3.40 x 1.60 cm (2.59 x 1.34 x 0.63 in.)
Note	For some of rack mount products, please note that the standard physical dimensions of WxDxH are expressed using a LxWxH format.

Diagram

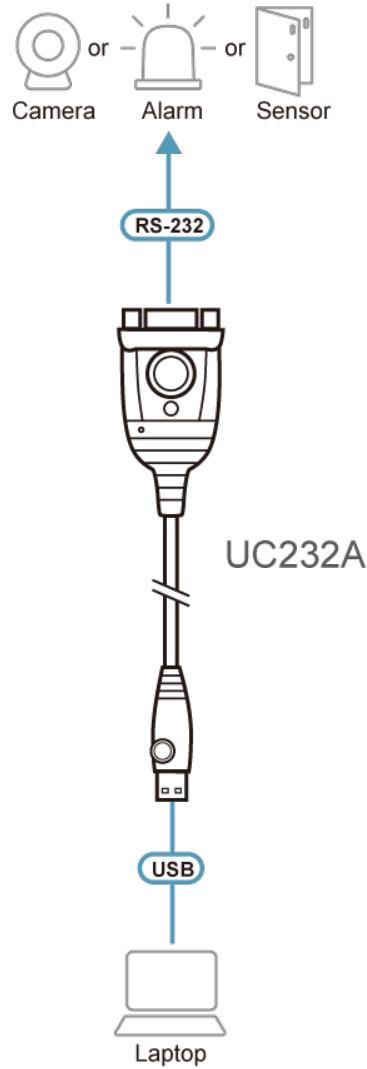

ATEN International Co., Ltd.

3F., No.125, Sec. 2, Datong Rd., Sijhih District., New Taipei City 221, Taiwan
Phone: 886-2-8692-6789 Fax: 886-2-8692-6767
www.aten.com E-mail: marketing@aten.com



© Copyright 2015 ATEN® International Co., Ltd.
ATEN and the ATEN logo are trademarks of ATEN International Co., Ltd.
All rights reserved. All other trademarks are the property of their respective owners.