

## 2XRT-0019G

ATEN PP4.0 Secure KVM Remote Port Selector



The ATEN PP4.0 [Secure KVM](#) Remote Port Selector (RPS) ,2XRT-0019G, is designed to enhance user experience and efficiency while operating ATEN PP4.0 [Secure KVM](#) Switches by providing an efficient way to switch between connected computers. Simply plug and play<sup>1</sup> the RPS to the [Secure KVM](#) Switch<sup>2</sup> without any additional software installation required to quickly and easily control your ATEN PP4.0 [Secure KVM](#) Switch. Once the RPS is connected, simply press the RPS pushbuttons to switch KVM focus. The status will show on both the KVM front panel LEDs and the RPS front panel LEDs. The RPS' Tamper-Evident Label and Always-on Chassis Intrusion Detection prevent any attempt at physical tampering, helping to safeguard classified data against malicious attacks. Thanks to its compact size, the device can be placed line-of-sight on the desktop, enabling instant switching across multiple PCs and optimizing productivity while eliminating cable clutter.

**Note:**

1. Make sure to connect the RPS before powering on the ATEN [Secure KVM](#) Switch. If the RPS is connected after the ATEN [Secure KVM](#) Switch is powered on, the RPS will not be detected.
2. The RPS is compatible with ATEN PP4.0 2/4/8-Port [Secure KVM](#) Switches.



**Features**

- Plug-and-Play – no additional software installation is required
- Auto Detection – works exclusively with ATEN PP4.0 2/4/8-Port [Secure KVM](#) Switches
- Always-on Chassis Intrusion Detection and Tamper-Evident Label
- Clear LED indications reflect real-time KVM status
- Compact size with 1.8 m cable for easy deployment

**Specifications**

Connectors	
Link	RJ-11
LEDs	
Online / Selected (KVM Port)	8 (Orange)
Online / Selected (CAC Port)	1 (Green)
Key Lock	3 (Green)
Cable Length	1.8 m
Maximum Input Power Rating	5V; 0.17A
Power Consumption	DC5V:0.15W:1BTU/h Note: <ul style="list-style-type: none"> <li>● The measurement in Watts indicates the typical power consumption of the device with no external loading.</li> <li>● The measurement in BTU/h indicates the power consumption of the device when it is fully loaded.</li> </ul>
Environmental	
Operating Temperature	0-50°C
Storage Temperature	-20-60°C
Humidity	0 - 80% RH, Non-condensing
Physical Properties	
Housing	Plastic
Weight	0.14 kg ( 0.31 lb )
Dimensions (L x W x H)	7.70 x 11.19 x 3.60 cm (3.03 x 4.41 x 1.42 in.)
Note	For some of rack mount products, please note that the standard physical dimensions of WxDxH are expressed using a LxWxH format.

Diagram

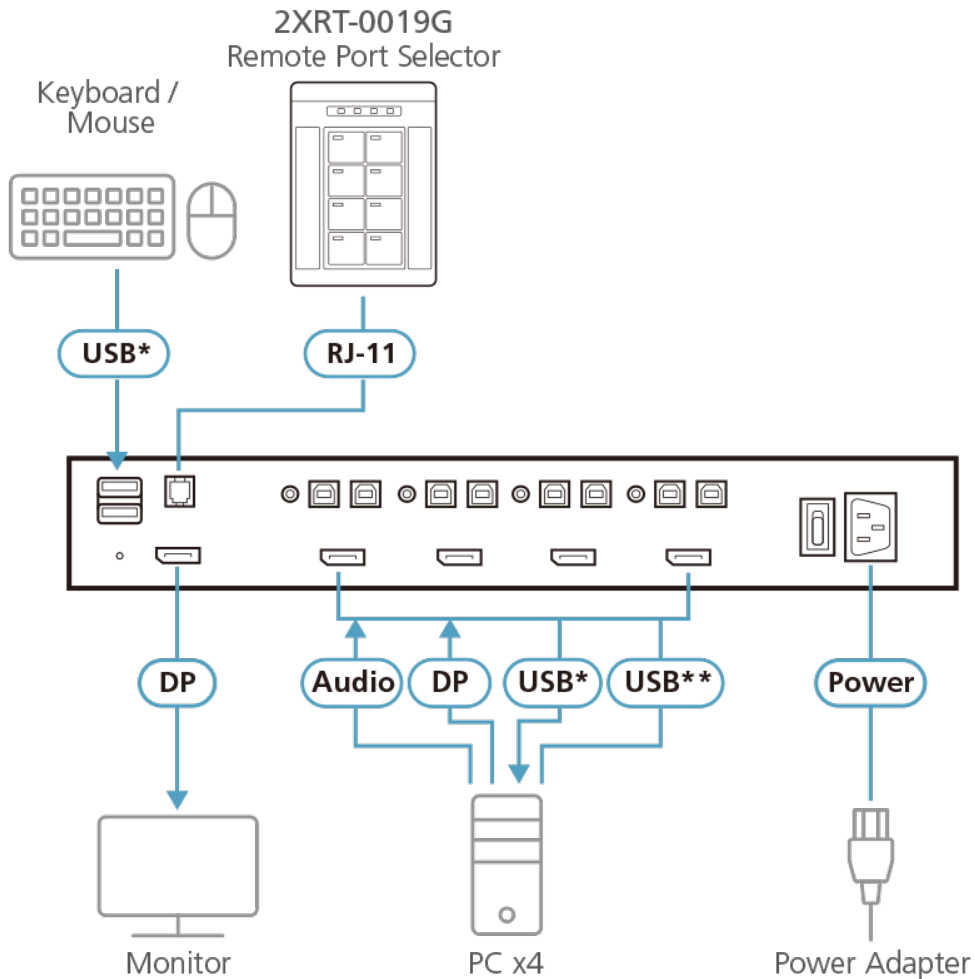

\*USB Keyboard / Mouse  
\*\*USB CAC

**ATEN International Co., Ltd.**

3F, No.125, Sec. 2, Datong Rd., Sijhih District., New Taipei City 221, Taiwan  
Phone: 886-2-8692-6789 Fax: 886-2-8692-6767  
www.aten.com E-mail: marketing@aten.com



© Copyright 2015 ATEN® International Co., Ltd.  
ATEN and the ATEN logo are trademarks of ATEN International Co., Ltd.  
All rights reserved. All other trademarks are the property of their respective owners.