

KX9980R

5K DisplayPort Dual Display KVM over IP Receiver



Re-Envision Control Rooms with 5K and Robust System Reliability

Zero-Latency IP Extension, Native DisplayPort Processing with 12-bit Deep Color



KX9980

5K DisplayPort Dual Display KVM over IP Extender

As workplaces face restructuring and decentralization is inevitably enforced, control room operations are being challenged to pivot effectively throughout these safety protocols in the new normal. Despite manpower shortages, managing escalations with secure, precise, and timely data from real-time monitoring and dynamic collaboration has become measurably more mission-critical than ever.

The KX9980 is a high-performance KVM over IP transmitter that allows connection to a DisplayPort computer and enables secure, remote, and uninterrupted access to the computer from a 5K DisplayPort KVM console connected to a KX9980 receiver over an Intranet or a dedicated LAN. With the receiver console installed at a separate location from the transmitter within a standard IP network, mission-critical control room operations become more ergonomic, user-centered, and task-oriented, while remaining separate from any adverse environmental interference.

The KX9980 expands on previous models with support for up to 10 Gbps optic fiber network connection, transcendent 5K audiovisual performance, speedy peripheral data sharing, and many other new features. This future-proof [KVM over IP Matrix](#) System solution, incorporating flexible extender connections, visual collaboration, and system control, aims to streamline control room workflows to jump start operators' productivity with KVM over IP agility.



12-bit Deep Color



Exceptional Visual Quality



Zero Latency



Network / Power Redundancy



Isochronous USB Transfer



Dual Display

Connect

Native DisplayPort Signal Processing with 12-bit Deep Colors

The essence of information visualization is in presenting the vividness of image coloring (ex. broadcast post production, meteorological analysis, etc). Powered by native DisplayPort signal processing with 8/10/12-bit color depth, the KX9980 delivers stunning visualization with a wider color spectrum comprising Adobe RGB / sRGB / YCbCr / YUV color spaces, facilitating lossless video compression over real-time KVM over IP data transmission.



Pixel-Perfect 5K Audiovisual Performance

The KX9980 revamps control room desktop operations with optimum image quality of 5K@60 Hz@4:4:4. Aided by the graphics card's dithering effect, the KX9980 brings a wider array of luminosity with smoother image rendering, providing an impactful user experience to considerably uplift control room productivity.

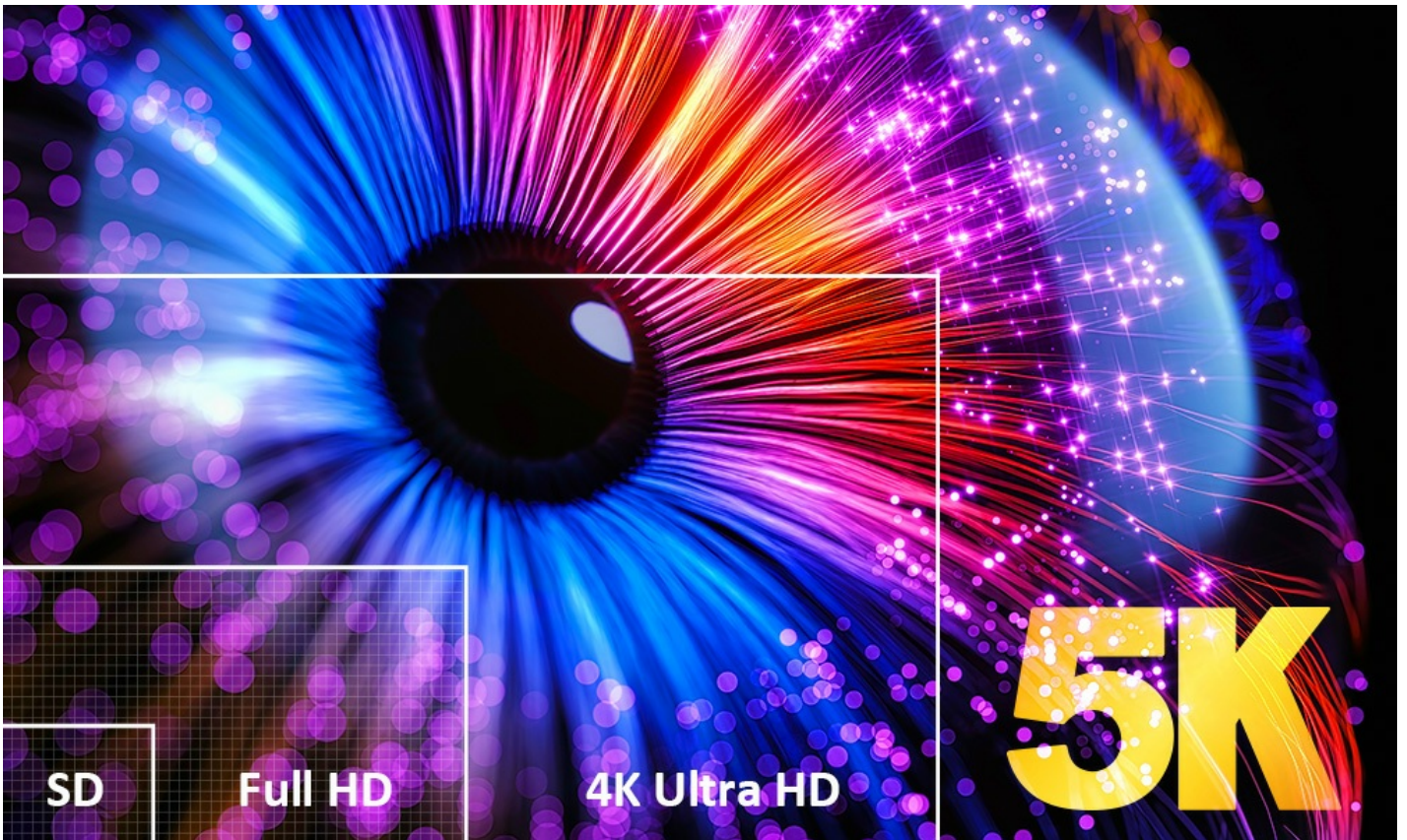

Spectacular Video FPS to Facilitate eSports Broadcasting

With eSports booming and beginning to rival traditional sports leagues in viewership, it's more important than ever to broadcast impeccable coverage of global gaming events and tournament where every tiny detail is crucial to viewers. The KX9980's support for 1920x1080@240Hz (CVT-RB) / 2560x1440 @144 Hz allows broadcasting producers to seamlessly switch live between on-scene players and gaming feeds without experiencing any impactful lag or interruption while the video is being streamed.



Enhanced Isochronous USB Transmission

In addition to peripheral sharing (such as cameras, microphones, speakers, and more), the USB peripheral ports are capable of isochronous transfer communication to facilitate USB data transmission at a higher rate.

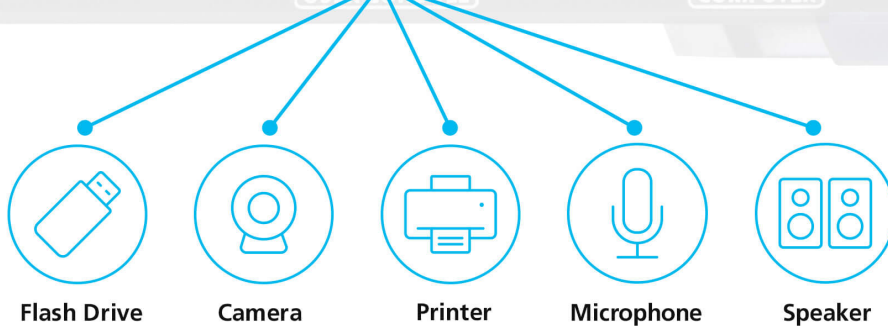
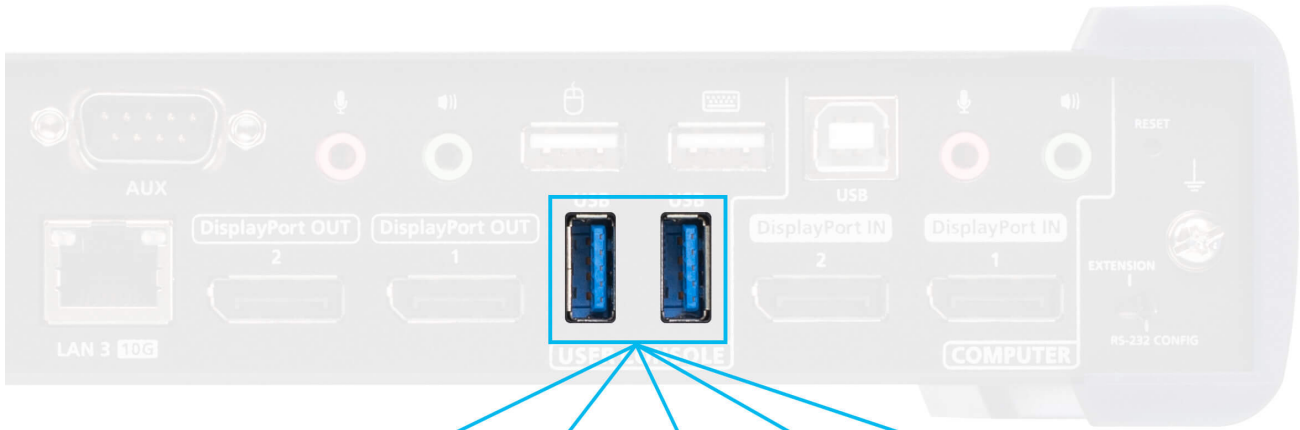

**Fail-Safe System with Network/Power Redundancy**

The KX9980 provides network/power redundancy that reinforces system reliability by maintaining uninterrupted operations and seamless power failover during any contingency. The KX9980 extenders are equipped with two SFP+ modules and one RJ-45 port to allow fiber and copper network connections, ensuring real-time data transmission and robust system uptime.

Panel Array™ Mode to Maximize Remote Console Efficiency

In tandem with [CCKM \(KVM over IP Matrix Manager\)](#), the operator at each remote console connected to a KX9980 receiver can benefit from ATEN's Panel Array™ mode that enables simultaneous view of video sources from multiple transmitters in 2x2 up to 6x6 multiview layout on one screen.

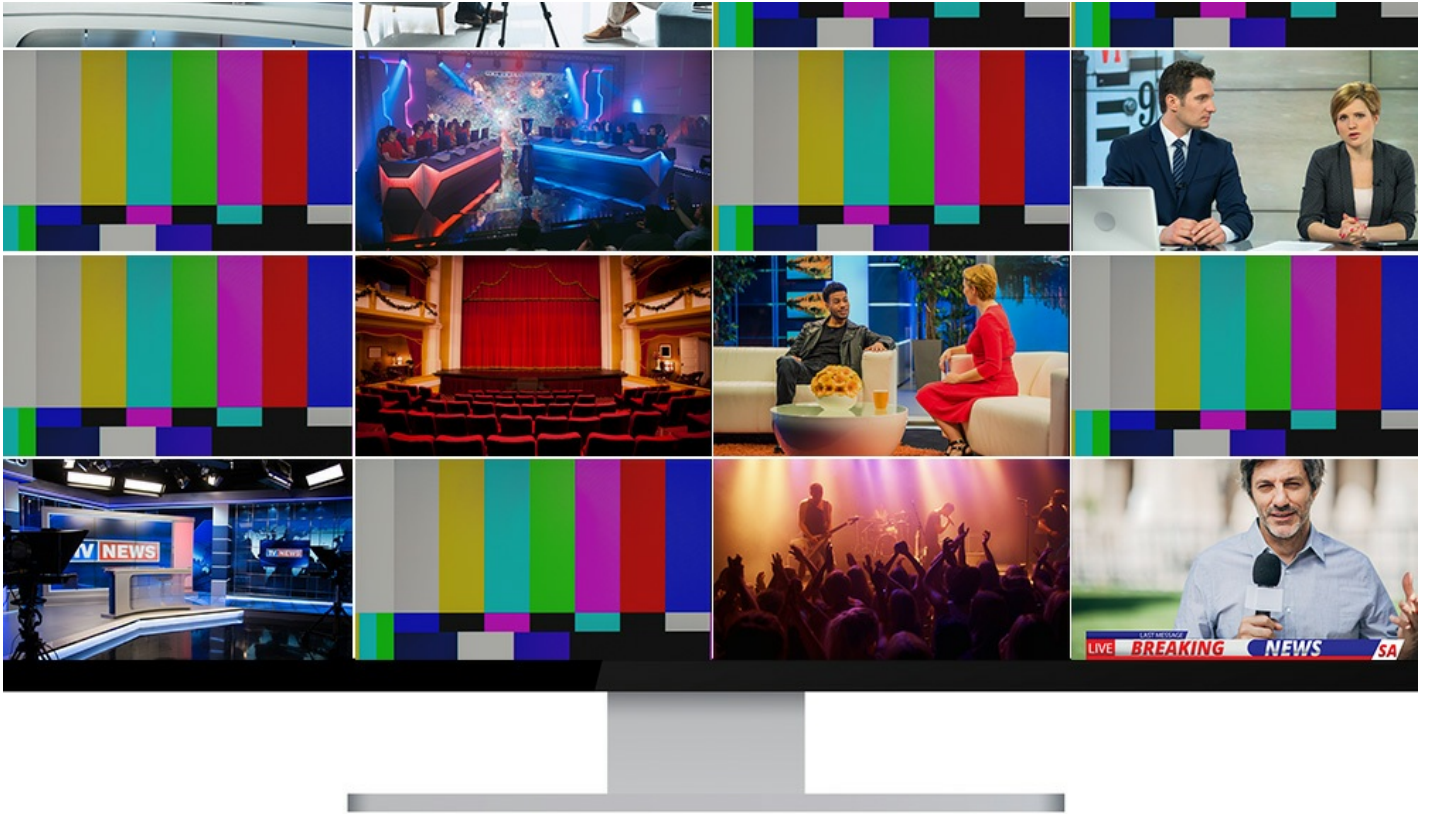

Effortless KVM over IP Extension

The KX9980 guarantees secure, extendable, and [zero latency KVM over IP](#) data transmission with no distance constraint to expedite real-time situational awareness for control room management. Extended data is bolstered with AES 256-bit encryption before transmission over the network and decrypted at the receiver for disclosure.



KVM over IP Control Access as Emergency Measure

The KX9980 comes equipped with a PS/2 port for connection to a KVM over IP Access Control Box ([2XRT-0015G](#)), which can be used to stop all remote receiver connections in times of emergency to allow technicians to perform timely troubleshooting and required maintenance at the local console.



Collaborate

Comprehensive Video Wall Collaboration to Reinforce Teamwork Efficiency

When integrating with the video wall, the KX9980 features ATEN's patented [Boundless Switching](#) which allows operators to intuitively switch control from one computer to another by moving the mouse cursor across screens, in order to respond to any incident with escalated awareness. Furthermore, all screen contents can be "pushed" and "pulled" for prompt collaboration, sharing, and troubleshooting as required between workstations and the video wall, facilitating a streamlined control room workflow to maximize informed decision making.

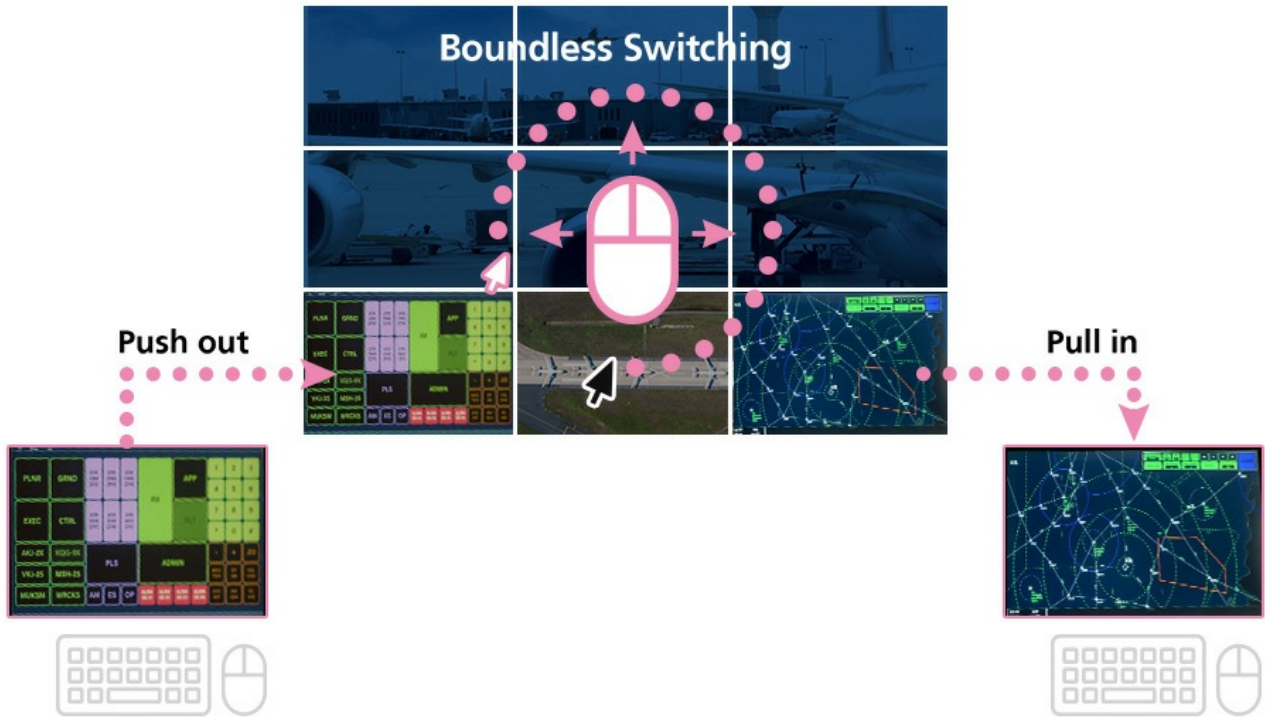

Control

KVM over IP Matrix System for Control Rooms of the Future

The KX9980 deployment is flexibly scalable, allowing point-to-point, point-to-multipoint, multipoint-to-point, and multipoint-to-multipoint installations to accommodate a multitude of industrial applications. The KX9980 extenders can be mixed and matched in a matrix configuration for installation, and this [KVM over IP Matrix](#) System allows for effortless and centralized management of all extender connections via [CCKM](#) – the [KVM over IP Matrix](#) Manager’s web GUI or an iPad app.

KVM over IP Matrix System

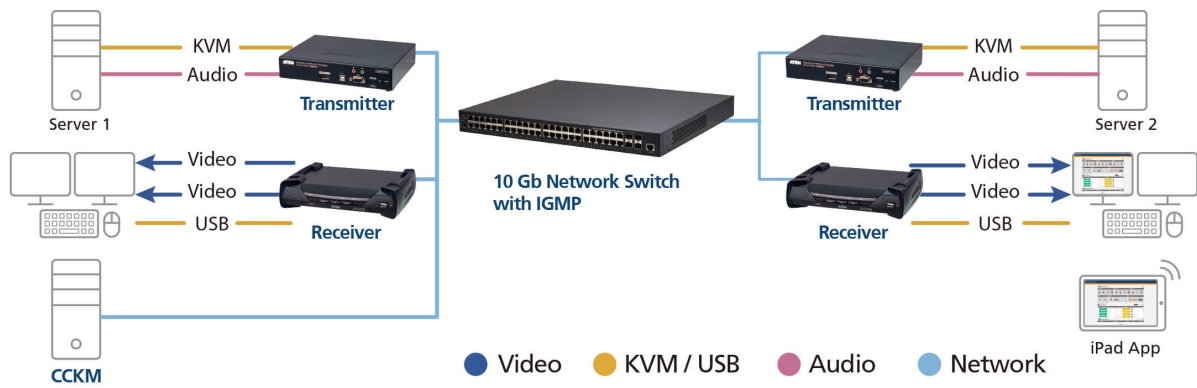

Applications

The KX9980 is perfectly suited to mission-critical control room applications where [secure KVM](#) over IP agility, real-time monitoring, and ergonomic desktop operations are demanded, including broadcasting NOCs, ATC towers, & [production line](#) monitoring. It is also ideal for professional gaming.



[Product Comparison](#)

[Talk to Our Experts](#)

If you prefer to have ATEN contact you, please complete the form and a representative will be in touch with you shortly

First Name *

Last Name *

- Country *

Company *

Email *

Phone Number

- Customer Type *

Job Title *

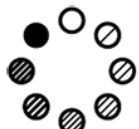

12-bit
Deep Color

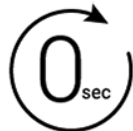

Zero Latency

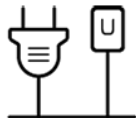

Network / Power
Redundancy

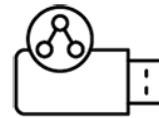

Isochronous
USB Transfer

Features

The KX9980 5K DisplayPort Dual Display KVM over IP transmitter is a high-performance IP-based Dual Display transmitter, where the transmitter can transmit a computer's keyboard, video, mouse, and USB signals to the receiver for providing separate console accesses from both the transmitter's and receiver's locations. The setup allows extended access to computer systems via a USB dual DisplayPort console (USB keyboard, USB mouse, Dual DisplayPort monitors) over Intranet, enabling users to place the computers in secure and temperature-controlled environments, which may be isolated from the user workstation.

The KX9980 supports two DisplayPort video displays for delivering video resolutions of up to 5K (5120 x 2880 @ 30 Hz), and offers flawless and lossless video quality with zero latency. The KX9980 is equipped with one RJ-45 port and two SFP+ slots. 10-Gbps SFP+ fiber module expansions are supported for fiber optic network connections and a transmission distance of up to 10 km. For connection flexibility, both the KX9980 transmitter and receiver models can be connected either directly to each other or via a high-speed network over a copper-based or fiber-based LAN. The KX9980 also features dual power supply capability for power redundancy to ensure reliable service. The KX9980 can be set up at the workstation, mounted onto a wall or at the rear of a rack with its [space-saving](#) 0U rack-mount design.

As an IP-based matrix extender, the KX9980 can be installed in flexible configurations, including point-to-point, point-to-multipoint, multipoint-to-point, and multipoint-to-multipoint. When combined with the [KVM over IP Matrix Manager \(CCKM\)](#), it can be integrated into a [KVM over IP matrix](#) system (multipoint-to-multipoint) for providing more flexible applications in different working environments.

By integrating [CCKM](#) with KX9980, IT administrators can benefit from advanced features such as auto detection of all KX9980 devices on the same subnet for fast installation or configuration, username / password authentication and authorization, and the ability to define different types of connections that can be switched and shared. Security features of the KX9980 include 256-bit AES encryption for secured data transmissions, as well as RADIUS, LDAP, Active Directory, TACACS+ for third-party authentication services. In conclusion, the KX9980 offers the most convenient solution for providing full digital extension over a network for control room applications, such as [air traffic control \(ATC\)](#), traffic management centers, and broadcast distribution monitoring systems.

Note: The SFP+ module ([2A-141G](#) / [2A-142G](#)) is sold separately. Contact your ATEN dealer for product information.

• Advanced Features¹

- Lossless video compression up to 5120 x 2880 for dual display, including UHD or DCI with zero latency
- Native DP signal processing with color depth 24, 30, 36 bits
- Supports Adobe RGB
- Supports USB isochronous transfer to enable USB camera and USB speaker usage between transmitter and receiver
- ATEN Matrix Link – allows users to instantly link transmitters and receivers to perform real-time port and profile switching on an iPad
- Boundless Switching – simply move the mouse cursor across screen borders to switch between different receivers (Rx)
- Fast Switching – switches between different remote video resolutions on a local display within 0.3 seconds
- Push and Pull – share content instantly to / from a single Rx or video wall by just one click
- Video walls – create multiple video walls with up to 12 x 12 (144 displays max.) in each layout
- Advanced Scheduling – improve efficiency and save costs by allowing connections to be set based on time and date
- Virtual Transmitter – independently stream video, audio, USB, and serial sources from different Tx
- Internal and external authentication support – supports LDAP, Active Directory, RADIUS, and TACACS+
- Advanced User Authorization Settings – administrators can set up to four access modes on Tx devices for collaboration or prevention of interference among users
- Configurable user and group permissions for access and control of KX devices
- Tx grouping of up to 4 sets of KX transmitters to support multi-display applications
- Rx access control – users at the Tx local console can enable / disable Rx control privilege by simply pressing a control button

Note:

1. These advanced functions are supported when the KX transmitters are paired with KX receivers and managed by [CCKM](#).
2. The KVM over IP Access Control Box ([2XRT-0015G](#)) is sold separately. Contact your ATEN dealer for product information.

Hardware

- Support dual display with 32:9 ultra-wide resolution (combined) or two individual displays
- Supports DisplayPort video resolutions – up to 5120 x 1440 @ 60 Hz (4:4:4), 5120 x 2880 @ 30 Hz (4:4:4), 4096 x 2160 @ 60 Hz (4:4:4), 1920 x 1080 @ 240 Hz (4:4:4) (CVT-RB), 2560 x 1440 @ 144 Hz (4:4:4) per display
- DisplayPort 1.2 compliant
- Stereo speakers and microphone support
- High-speed USB Storage Transmission support
- Auto-MDIX – automatically detects cable type
- Built-in 8 kV / 15 kV ESD protection and 2 kV surge protection
- Supports power redundancy – KX9980 has 2 DC jacks for power redundancy
- Supports network failover – 1 RJ-45 & 2 SFP+ slots for network failover to ensure constant availability for missioncritical applications
- Supports 10-Gbps SFP+ fiber module expansions for up to 10 km*
- The housing meets IEC 60945 standards for maritime control room use and has passed environmental tests
- Rack Mountable – Mounting options:
 - [2X-021G](#) Dual Rack Mount Kit
 - [2X-031G](#) Single Rack Mount Kit
- Includes an industrial-grade power adapter – supports operating temperature of 0 – 50 °C to ensure durability and adaptability under harsh environmental conditions

Note:

*The SFP+ module ([2A-141G](#) / [2A-142G](#)) is sold separately. Contact your ATEN dealer for product information.

Management

- Integration with [KVM over IP Matrix Manager \(CCKM\)](#) – a software enabling easy configurations of all KX devices with an intuitive web-based GUI
- Dual console operation – controls user's system from both the transmitter's and receiver's keyboard, monitor, and mouse
- OSD (On Screen Display) – enables configuration of both Tx / Rx devices on the receiver's display screen
- EDID Expert™ – selects optimum EDID settings to prevent video compatibility issue caused by different monitors
- On-screen Preview (Panel Array™Mode) – allows users to view the video of up to 36 displays on one screen
- Video Compression Level – allows users to increase / decrease the video quality to adjust for appropriate network bandwidth
- Command Line Interface – administrators can control all KX devices via RS-232 or Telnet by issuing commands or 3rdparty application
- Supports hotkey commands
- RS-232 serial ports – allows users to connect to a serial terminal for TextMenu, CLI, or to serial devices such as touch screens and barcode scanners
- All KX Tx models are compatible to be used with all Rx models

Security

- Dedicated LAN port for KX direct connections – can be isolated from the corporate network
- Secured data transmission – 256-bit AES encryption for all data being transmitted from the transmitter to the receiver
- Supports industry standard Transport Layer Security (TLS) protocol

Virtual Media

- Virtual Media mode enhances data transmission performance, and is ideal for file transfers, OS patching, software installations and diagnostic testing
- Supports USB 2.0 DVD / CD drives, USB mass storage devices, PC hard drives and ISO images
- Supports smart card / CAC reader

Specifications

Connectors	
USB Port	2 x USB Type A Female (White)
Console Ports	2 x USB Type A Female (Blue) 1 x USB Type A Female (White) 2 x DisplayPort Female (Black) 1 x Mini Stereo Jack (Green) 1 x Mini Stereo Jack (Pink) 1 x DB-9 Male (Black)
Computer Ports	*Computer ports for future enhancements 1 x USB 2.0 Type B Female (white) 2 x DisplayPort Female (Black) 2 x Audio Jack Female (Pink for Mic., Green for Ear Phone, Front Panel)
Power	2 x DC Jack (Black)
LAN Ports	1 x RJ-45 (Black) 2 x SFP+ Slot
Switches	
OSD	1 x Pushbutton
Port (Up)	1 x Pushbutton
Port (Down)	1 x Pushbutton
Reset	1 x Semi-recessed Pushbutton
Power	2 x Power Switch
LEDs	
1000/10000 Mbps	1 (1000: Orange / 10000: Green)
Power	2 (Green)
Local	1 (Green)
Remote	1 (Green)
Emulation	
Keyboard / Mouse	USB
Power Consumption	DC12V:33W:237BTU/h Note: ● The measurement in Watts indicates the typical power consumption of the device with no external loading. ● The measurement in BTU/h indicates the power consumption of the device when it is fully loaded.
Video Resolution	Up to Dual-Display: 5120 x 2880 @ 30Hz, 5120 x 1440 @ 60Hz, 4096 x 2160 @ 60Hz, 2560 x 1440 @ 144hz, 1920 x 1080 @ 240Hz
Latency	< 1ms
Environmental	
Operating Temperature	0–50°C
Storage Temperature	-20–60°C
Humidity	0–95% RH, Non-condensing
Physical Properties	
Housing	Metal
Weight	1.69 kg (3.72 lb)
Dimensions (L x W x H)	22.60 x 22.40 x 5.30 cm (8.9 x 8.82 x 2.09 in.)
Note	For some of rack mount products, please note that the standard physical dimensions of WxDxH are expressed using a LxWxH format.

Diagram

► Diagram

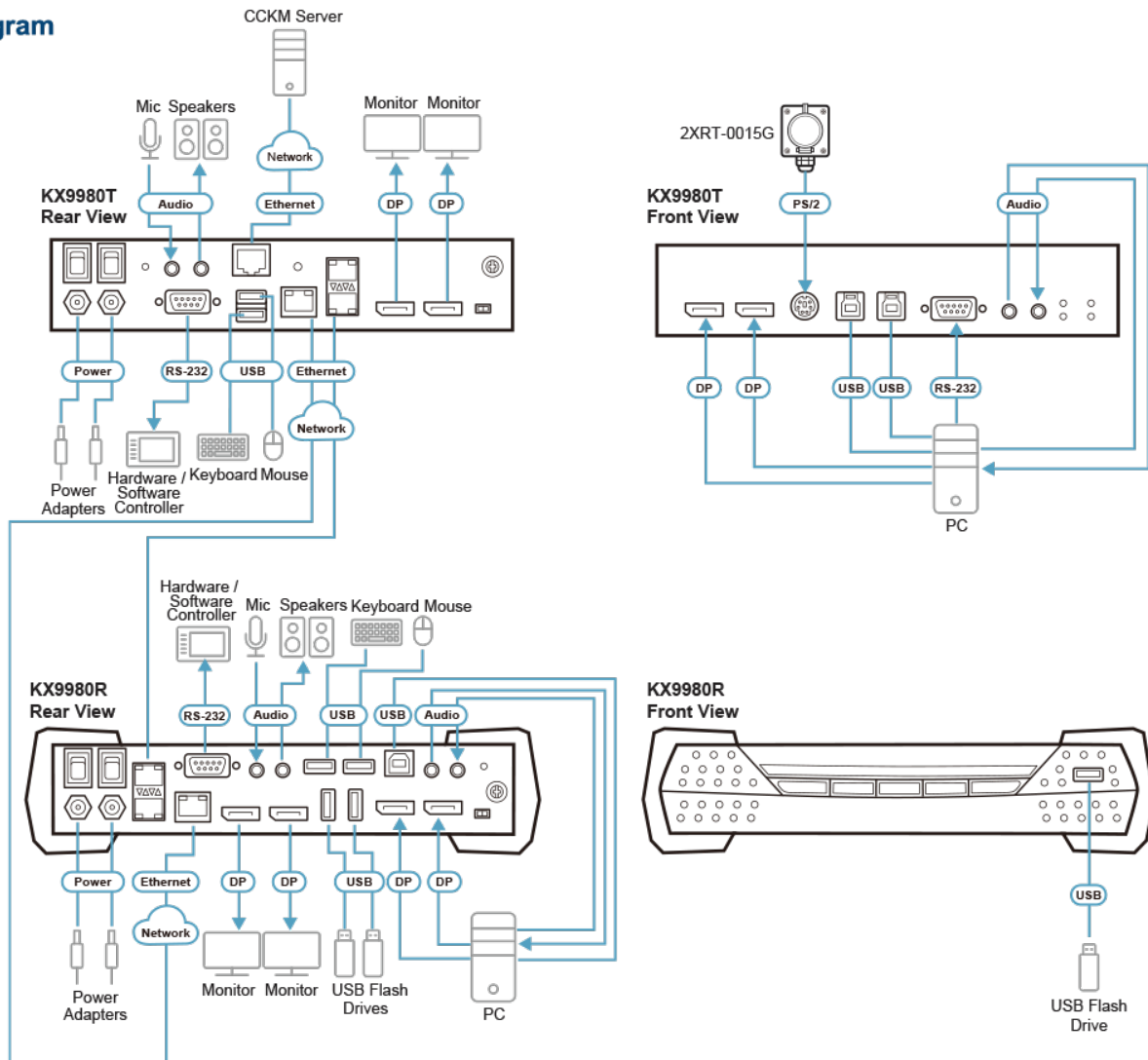

ATEN International Co., Ltd.

3F., No.125, Sec. 2, Datong Rd., Sijhih District., New Taipei City 221, Taiwan
 Phone: 886-2-8692-6789 Fax: 886-2-8692-6767
 www.aten.com E-mail: marketing@aten.com



© Copyright 2015 ATEN® International Co., Ltd.
 ATEN and the ATEN logo are trademarks of ATEN International Co., Ltd.
 All rights reserved. All other trademarks are the property of their respective owners.