

### CS19216

16-Port USB 3.0 4K DisplayPort KVM Switch



# Streamline Server Management with 4K USB 3.0 Rack KVM Efficiency

CS18208 / CS18216  
CS19208 / CS19216 ▶



Maintaining effective IT operations is crucial to keeping businesses and services running. With workforces navigating the adjustments of the new normal, sustaining 24/7 uninterrupted IT services while remaining competitive has become more mission-critical than ever. Meanwhile, as the amount of data has continued to grow exponentially over the years, boosting operational efficiency remains the focal point for [data center](#) and server room professionals as they strive to streamline routine procedures in automated processes, such as data entry, feature testing, BIOS flash, system updates, and much more.

The CS19216, featuring superior 4K video quality, USB 3.0 peripheral agility, and [space-saving](#) rackmount capability, allows 16 computers to be centrally controlled via a single console where IT engineers are enabled to expedite system operations by configuring multiple units simultaneously instead of working one at a time; routine or repetitive tasks and procedures can be promptly replicated and broadcasted on multiple computers in seconds, slashing time, space, and cost, while pursuing strengthened enterprise productivity.



Superior Visual Clarity



Video DynaSync™

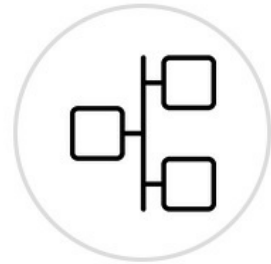

Scalability



Multi-Display Setup



Multiplatform Support



USB 3.0 Peripheral

**Spectacular 4K DCI Visual Performance**

With connection to HDMI or DisplayPort-enabled computers, 4K USB 3.0 Rack KVM Switch series effortlessly enriches console desktop operations with up to 4K DCI (4096 x 2160 @60 Hz) visual excellence. Video sources of high resolution visuals and imaging are displayed with great precision for improved analysis.



**Video DynaSync™**

Empowered by patented ATEN technology – Video DynaSync™, Rack KVM Switches deliver a smooth viewing experience by maintaining the ideal video settings under all operating systems when switching between ports, speeding up switching between systems, and powering up uninterruptedly while eliminating boot-up display problems.

**without Video DynaSync™**



After port switching...

**with Video DynaSync™**

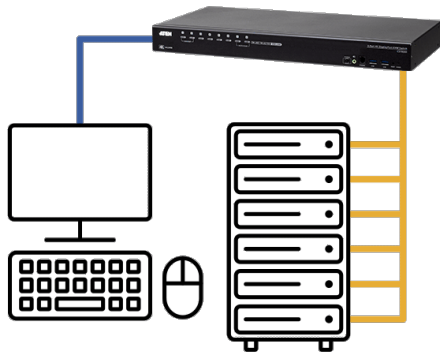

**Broadcast Mode to Expedite Timely Configurations**

The practical and efficient Broadcast Mode can be easily invoked via OSD or serial commands to perform the same task or command simultaneously on all connected computers across different OS platforms, including software installation and upgrading, function testing, BIOS flash update, system-wide shutdown, and more, making server management effortless and hassle-free.



**Cascadability to Upscale Server Management Efficiency**

The number of connected computers can be scaled up to 128 by cascading the [CS19208](#) in 1st level and the CS19216 in 2nd level (or the CS19216 in 1st level and the [CS19208](#) in 2nd level), leaving room and flexibility for network expansion when needed.

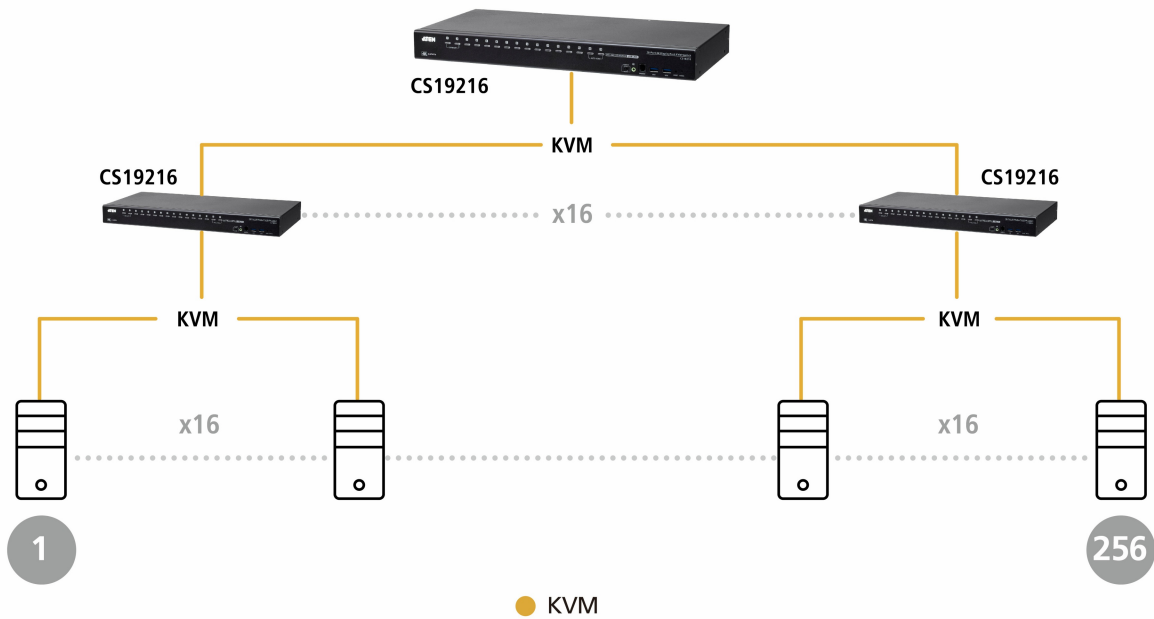

**Resilient Multi-Display Setup to Facilitate Live Feeds**

When a large amount of complex content needs to be viewed at once or there's a need to examine intensive data for analysis, up to 8 Rack KVM Switches can be stacked up to allow up to 8 monitors to be set up in a multi-display configuration (such as dual- / triple- / quad-display) to facilitate live feeds among computers at the console desktop.

## Quad-Display Setting

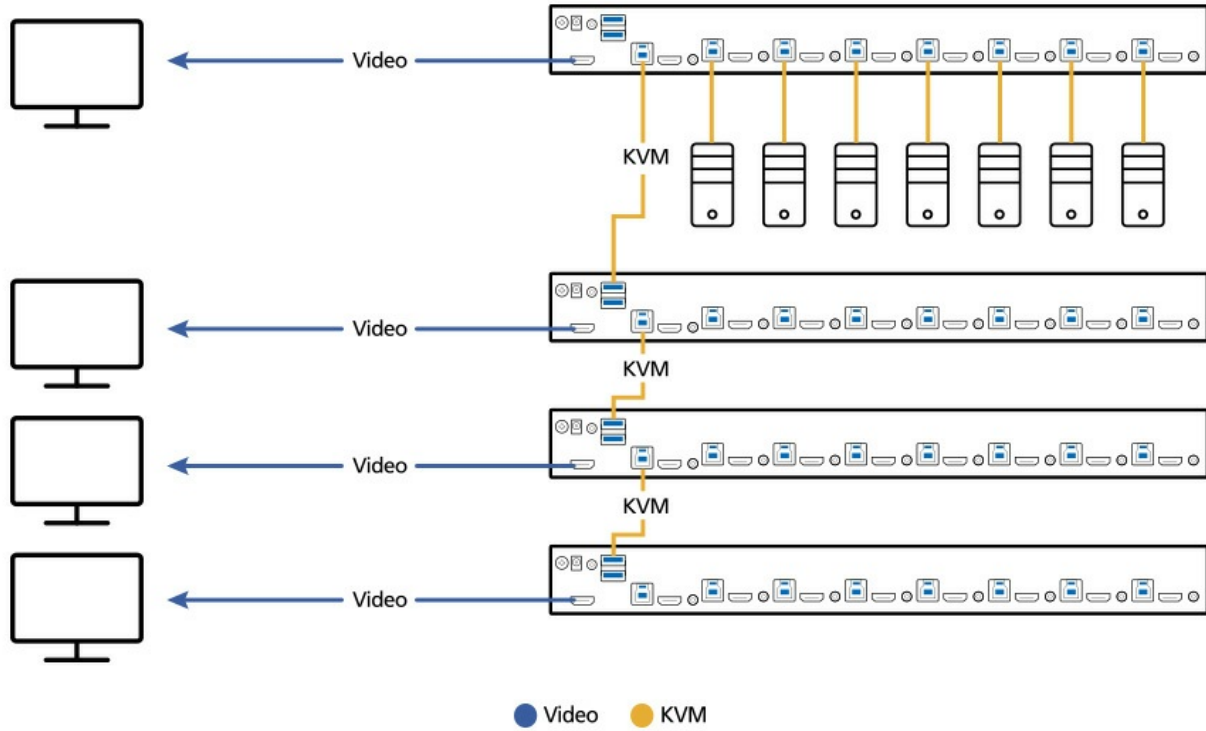

## Contact Us

Get a quote for this product or get in touch with our sales experts

[Get Quote](#)

[Contact Sales](#)

### Superb Data Transfer Rate for Swift Peripheral Sharing

The built-in 2-port USB 3.1 Gen 1 hub supports plug-n-play connection to two peripheral devices (e.g., printer, scanner, flash drive, etc.) for high-speed data transmission of up to 5 Gbps transfer rate, making console desktop operations agile and efficient.



**Flexible Port-Switching Methods for Uplifted Productivity**

Port switching is as easy and convenient as pressing the front-panel pushbuttons, pressing supported hotkeys, using the OSD, or entering RS-232 commands, whichever works best for you.



Hotkey

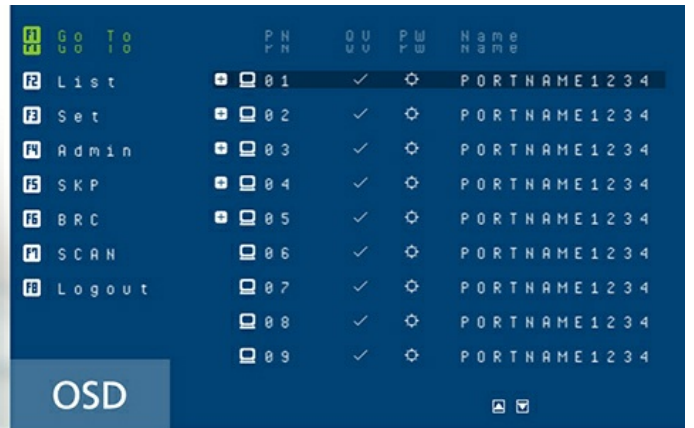

OSD



Pushbutton

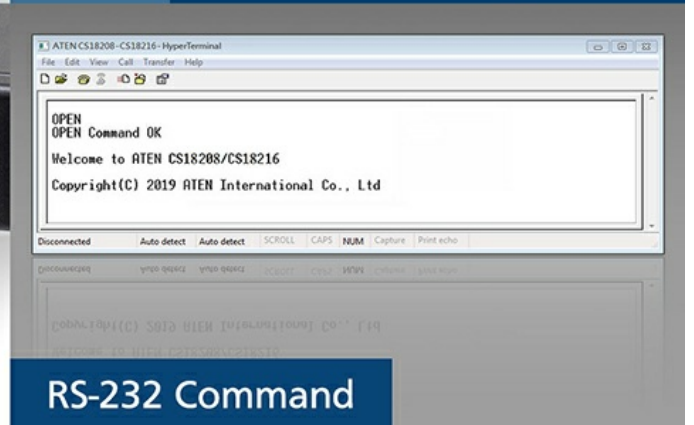

RS-232 Command

**Space-Efficient 2-in-1U Rack Mounting**

The ATEN 2-in-1U Mounting Kit (model: [2K-0001](#) / [2K-0002](#)) enables the housing of an ATEN Rack KVM Switch with an ATEN Ultra [Short Depth](#) LCD Console in a 1U rack space, facilitating rack installation with optimum space efficiency.



**Applications**



## Sever Room Management

## Production Line Automation

Product Comparison

### Talk to Our Experts

If you prefer to have ATEN contact you, please complete the form and a representative will be in touch with you shortly

First Name \*

Last Name \*

- Country \*

Company \*

Email \*

Phone Number \*

- Customer Type \*

Job Title \*



**Features**

The ATEN CS19216 16-Port USB 3.0 4K [DisplayPort KVM Switch](#) can effectively access and control up to 16 DisplayPort computers from a single USB keyboard, USB mouse, and monitor console. With its dual interface console, users can choose between DisplayPort/HDMI video output supporting high video quality up to 4K DCI (4096 x 2160 @ 60Hz), presenting crystal-clear visuals.

To meet the needs of easy expansion and flexibility, the CS19216 can be cascaded to two levels to control up to 256 computers from a single console. Furthermore, the CS19216 supports multi-display function by stacking up to eight CS19216 units to compare and analyze information on 8 monitors at most, which substantially streamlines the working environment.

With two patented ATEN technology – [Video DynaSync™](#) and EDID Expert™, the CS19216 can optimize display resolution, accelerate switching between ports and power up smoothly while eliminating boot-up display problems.

Besides, the CS19216 comes with a built-in USB 3.1 Gen 1 hub delivering data transfer rates up to 5 Gbps, allowing users to speed up operations and share USB peripherals instantly. For user-friendly port selection methods, the C19216 offers pushbuttons, hotkeys, RS-232 commands, and OSD with newly-designed UI, bringing effortless and intuitive operations.

To eliminate security concern, a two-level password authorization is available to enhance security protection for accessing and controlling computers. Consolidating these advantageous functionalities, the CS19216 is ideal for server room/computer room management applied in industries with requirements for high-quality images and multitasking, such as Enterprise, Government, Production, Telecom, Finance, Medical Healthcare, Industrial Automation, etc.

- One USB console controls up to sixteen DisplayPort interface computers and two additional USB 3.0 peripheral devices
- Cascadable to two levels – controls up to 256 computers <sup>1</sup>
- Multi-Display feature – stack up to eight CS19216 units and display video from up to 8 monitors (dual display / triple display / quad display / multi-display)
- Video DynaSync™ – an exclusive ATEN technology that eliminates boot-up display problems and optimizes the resolution when switching among different sources
- EDID Expert™ – selects optimum EDID mode for smooth power-up and highest quality display
- Supports a DisplayPort or HDMI video output – allows you to choose an appropriate video output and deploy console with flexibility
- Superior video quality – up to 4K DCI (4096 x 2160 @ 60Hz)
- Built-in 2-port USB 3.1 Gen 1 hub with SuperSpeed 5 Gbps data transfer rates
- Audio enabled – full bass response provides a rich experience for 2.1 channel stereo sound
- Supports HD audio <sup>2</sup>
- Computer selection via pushbuttons, hotkeys, OSD, and RS-232 commands
- Independent switching of KVM and USB peripheral focus <sup>3</sup>
- Two-level (administrator/user) password authorization for enhanced security protection
- Broadcast mode – operations can be simultaneously performed on all selected computers, such as software installation and upgrading, system-wide shutdown, etc.
- Auto Scan Mode for monitoring all computers
- Console mouse port emulation/bypass feature supports most mouse drivers and multifunction mice
- Multilingual keyboard mapping – supports English (US), English (UK), German (GER.), German (SWISS), French, Hungarian, Italian, Japanese, Korean, Russian, Spanish, Swedish, Traditional Chinese, and Simplified Chinese
- Mac/Sun keyboard support and emulation <sup>4</sup>
- Supports hot-plugging
- DisplayPort 1.2 compliant; HDCP 2.2 compliant
- Multiplatform support – Windows, Linux, Mac, and Sun
- Firmware upgradable
- Supports multimedia, wireless keyboards and mouse

**Note:**

1. Cascading between [CS19208](#) and CS19216 is available.
2. HD audio through HDMI and DisplayPort channel cannot be switched independently.
3. Independent switching is only supported under mouse emulation mode.
4. PC keyboard combinations emulate Mac/Sun keyboards; Mac/Sun keyboards work only with their own computers.

Specifications

Computer Connections	
Direct	16
Maximum	256 (via Cascade)
Port Selection	OSD, Hotkey, Pushbutton, RS-232Commands
Connectors	
Console Ports	1 x DisplayPort Female 1 x HDMI Female (Black) 2 x USB Type A Female 2 x 3.5mm Audio Jack Female (Green; 1 x front, 1 x rear)
KVM Ports	16 x DisplayPort Female 16 x USB3.1 Gen1 Type B Female (Blue) 16 x 3.5mm Audio Jack Female (Green)
Firmware Upgrade	1 x RJ11 Female (Black)
Power	1 x DC Jack
USB Hub	2 x USB3.1 Gen1 Type A Female (Blue; 2 x front)
Switches	
Port Selection	16 x Pushbutton
Reset	1 x Semi-recessed Pushbutton
Firmware Upgrade Recovery	1 x Slide Switch
LEDs	
On Line /Selected	16 (Orange)
Power	1 (Green)
USB Link	16 (Green)
Emulation	
Keyboard / Mouse	USB
Video	DisplayPort: 4096 x 2160 @ 60Hz; HDMI: 4096 x 2160 @ 60Hz
Scan Interval	0 – 255 seconds (default: 5 secs.)
Power Consumption	DC12V:26.66W:175BTU/h  Note: ● The measurement in Watts indicates the typical power consumption of the device with no external loading. ● The measurement in BTU/h indicates the power consumption of the device when it is fully loaded.
Environmental	
Operating Temperature	0 – 40°C
Storage Temperature	-20 – 60°C
Humidity	0 – 80% RH, Non-condensing
Physical Properties	
Housing	Metal
Weight	3.54 kg ( 7.8 lb )
Dimensions (L x W x H)	43.24 x 21.43 x 4.40 cm (17.02 x 8.44 x 1.73 in.)
Note	For some of rack mount products, please note that the standard physical dimensions of WxDxH are expressed using a LxWxH format.

Diagram

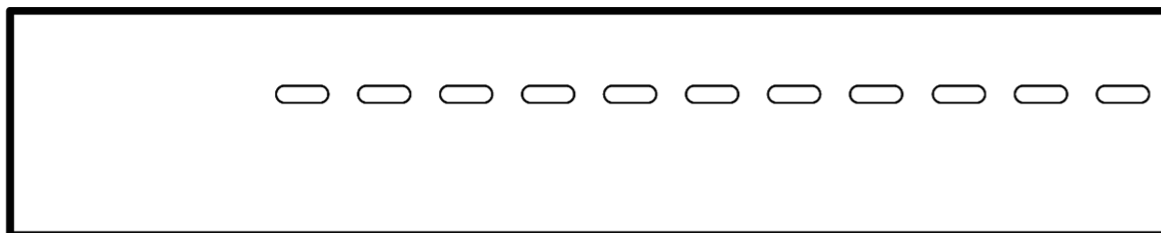

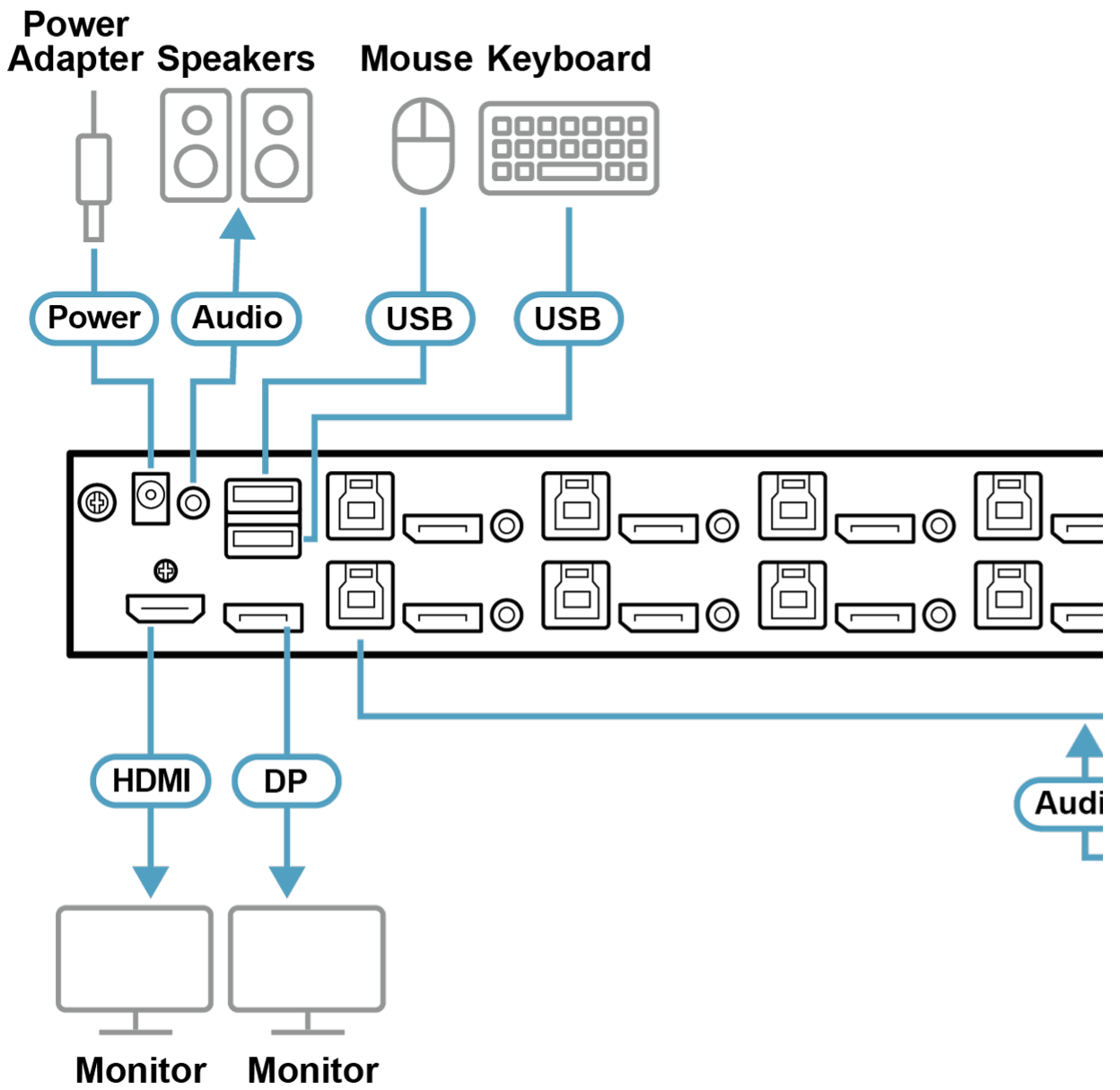



Simply Better Connections

**ATEN International Co., Ltd.**

3F., No.125, Sec. 2, Datong Rd., Sijhih District., New Taipei City 221, Taiwan  
Phone: 886-2-8692-6789 Fax: 886-2-8692-6767  
www.aten.com E-mail: marketing@aten.com



© Copyright 2015 ATEN® International Co., Ltd.  
ATEN and the ATEN logo are trademarks of ATEN International Co., Ltd.  
All rights reserved. All other trademarks are the property of their  
respective owners.