PG98330

30A/32A 30-Outlet 3-Phase Outlet-Metered & Switched eco PDU



Optimize Data Center Sustainability

Up to 64 Cascaded 3-Phase PDUs with Space, Energy, and Connectivity Efficiency



When maintaining operating uptime in a data center or server room, sustainable energy efficiency can make all the difference. The implementation of effective power management often involves improvements at both the hardware and software level. As the trend for 3-phase power grows due to its efficiency to generate, transfer, and distribute electricity, ATEN is introducing its latest PG series of PDUs, available in IEC socket configuration, that are designed with 0U rack housing to accommodate the increasing demand for power to high-density IT equipment in server rooms and data centers. Each PG98330 PDU, utilizing an ARM-Cortex A8 processor, is equipped with 30 port outlets capable of running at higher voltages, powers up all connected equipment in less than 10 seconds once plugged in, and delivers the most accurate kWh energy usage data (+/-1%) for better power consumption habits, baselines, and initiative tracking. With energy saving in mind, the PG98330 is purposed to enable lower energy consumption for best practice in a network infrastructure, while promoting up to 70.65 kg (131.4 kw equivalent of power consumption) of reduced CO2 emission, reduced electricity expenses, and lower carbon taxes to pay each year.

kWh \pm 1%

kWh Metering Precision



3-Phase Power

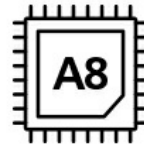

ARM Cortex-A8 Processor

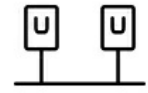

Network Redundancy



Power Monitoring



Environmental Monitoring



Console Panel Color Coding



Outlet LED Indicator

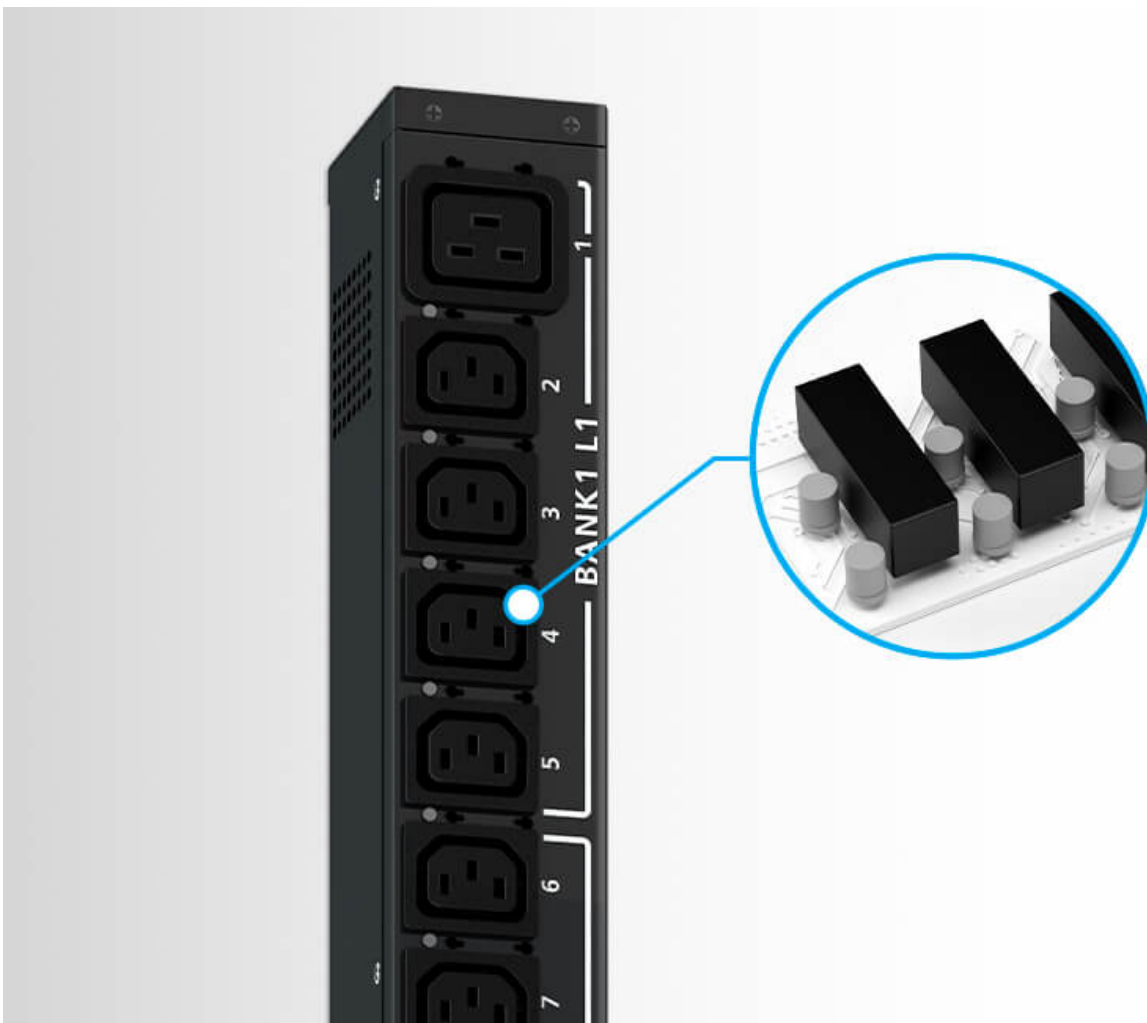

Energy-Saving Relay

Thanks to the built-in energy-saving relays – a subtype of electromagnetic switch – controlling a large amount of current flow becomes easy, which results in annual saving of 131.4 kW power

consumption per 30-outlet PDU unit, compared with models without energy-saving relays. In addition, power distribution will remain functional and uninterrupted even when a failure occurs, enabling superior uptime to optimize system reliability.

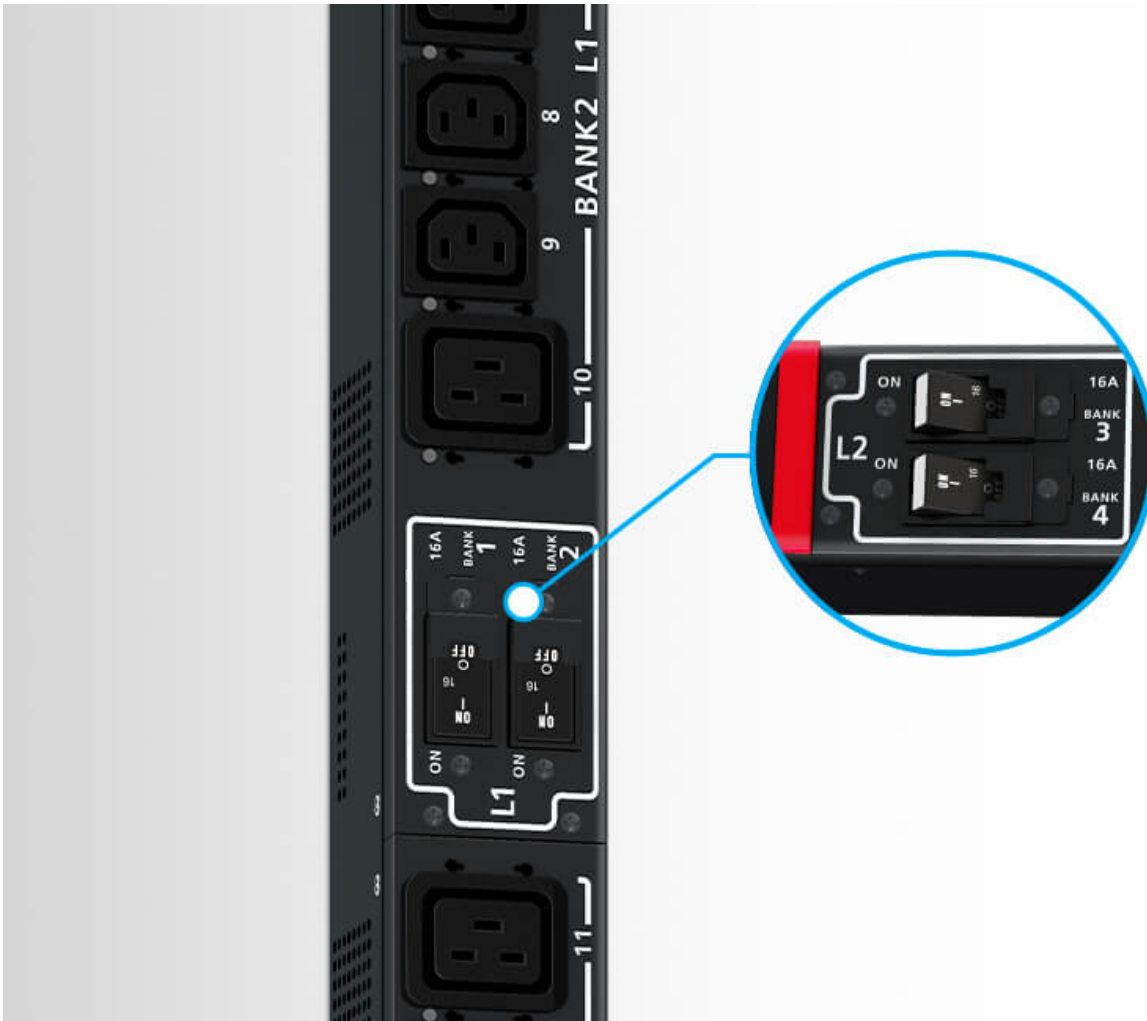

Hydraulic-Magnetic Circuit Breaker

With the built-in hydraulic-magnetic circuit breaker in place, electricity supply can be automatically switched off to protect connected devices from getting overloaded or damaged, while maintaining stable power distribution.

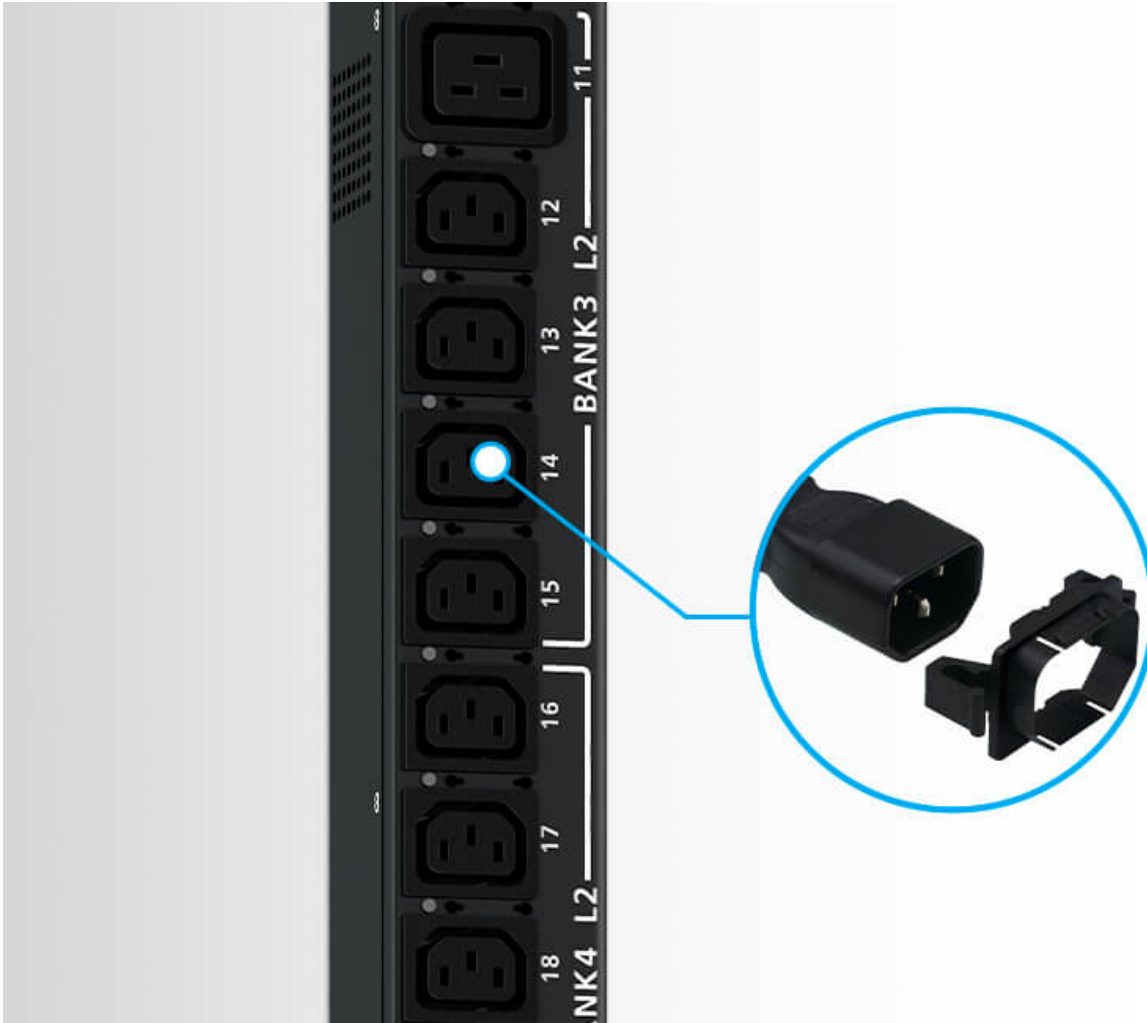

Secure Locking Enhancement

The outlets can be protected with a secure lock to prevent power cords from becoming unplugged due to vibration or human errors.



Real-time Alerts via LCD Display

The illuminated LCD display can display warnings to alert users of unusual power states.

Hot-Swappable Function

The LCD console panel is hot-swappable and can be removed, replaced, or repaired without powering down a mission-critical connected load.

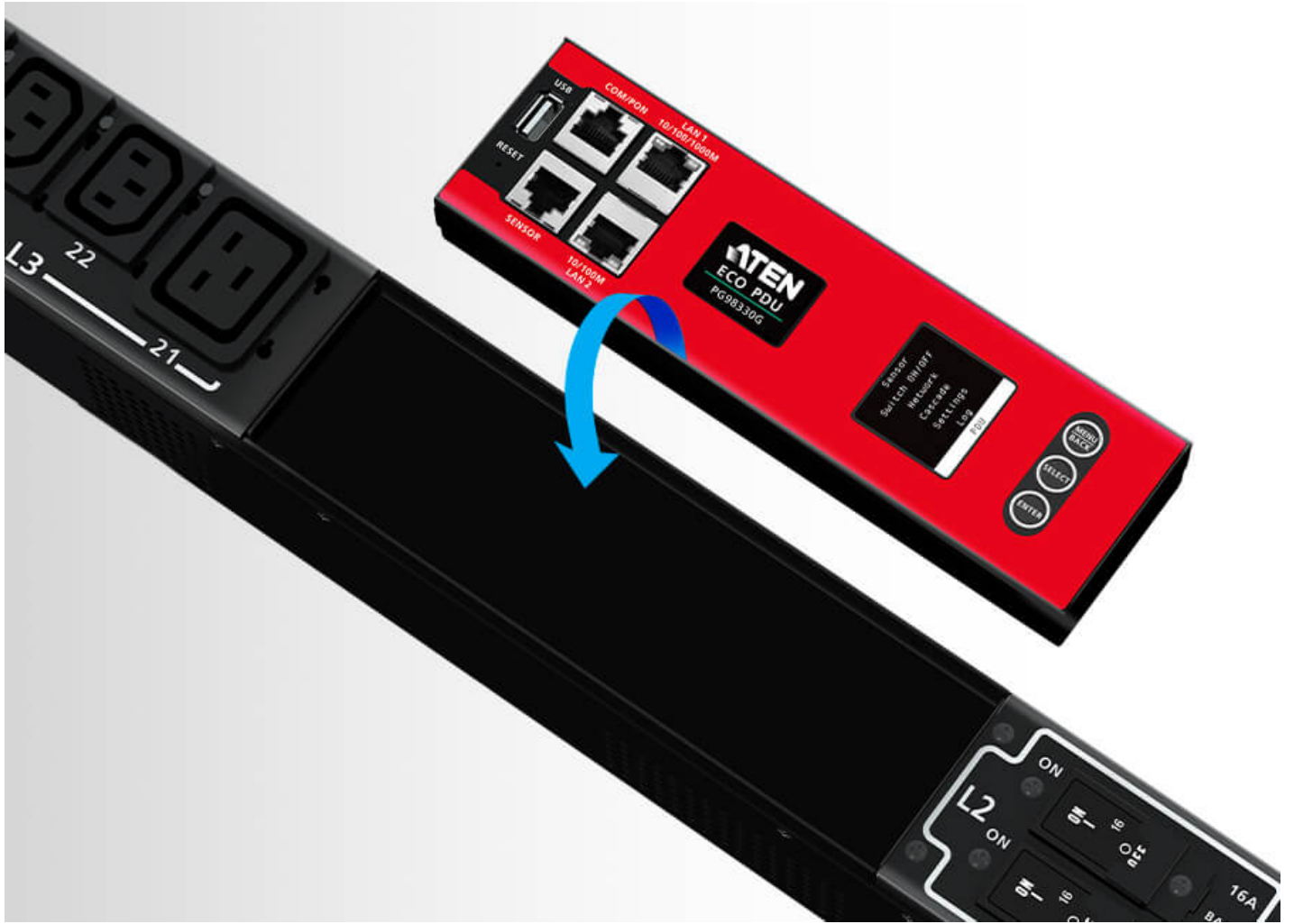



Dual LAN Ports for Scalable Network Setup

The PG98330 is equipped with dual LAN ports (e.g. Internet and Intranet) supporting up to 1G Ethernet connection, and can be cascaded to connect up to 64 PDUs, saving expense on installing extra network switches to incorporate network connections while sparing more rack space to accommodate more IT equipment in an expandable network.

Environment Sensors

The Sensor port enables RJ-45 connectivity to connect or daisy-chain up to 8 environment sensors for monitoring and management of temperature, humidity, airflow, differential air pressure, and leaks, featuring alerts for potential threats.





Flexible On-Site Network Operation

For quick operation, connecting a serial device to the PDU with its COM port provides another means to undertake communication via CLI commands. In addition, the same port is also functional as a PON port, available for Ethernet connection to a KN series KVM over IP Switch to centralize power management of up to 16 daisy-chained PDUs.

Note: This feature is to be included in a future firmware release.

Contact Us

Get a quote for this product or get in touch with our sales experts

[Get Quote](#)

[Contact Sales](#)

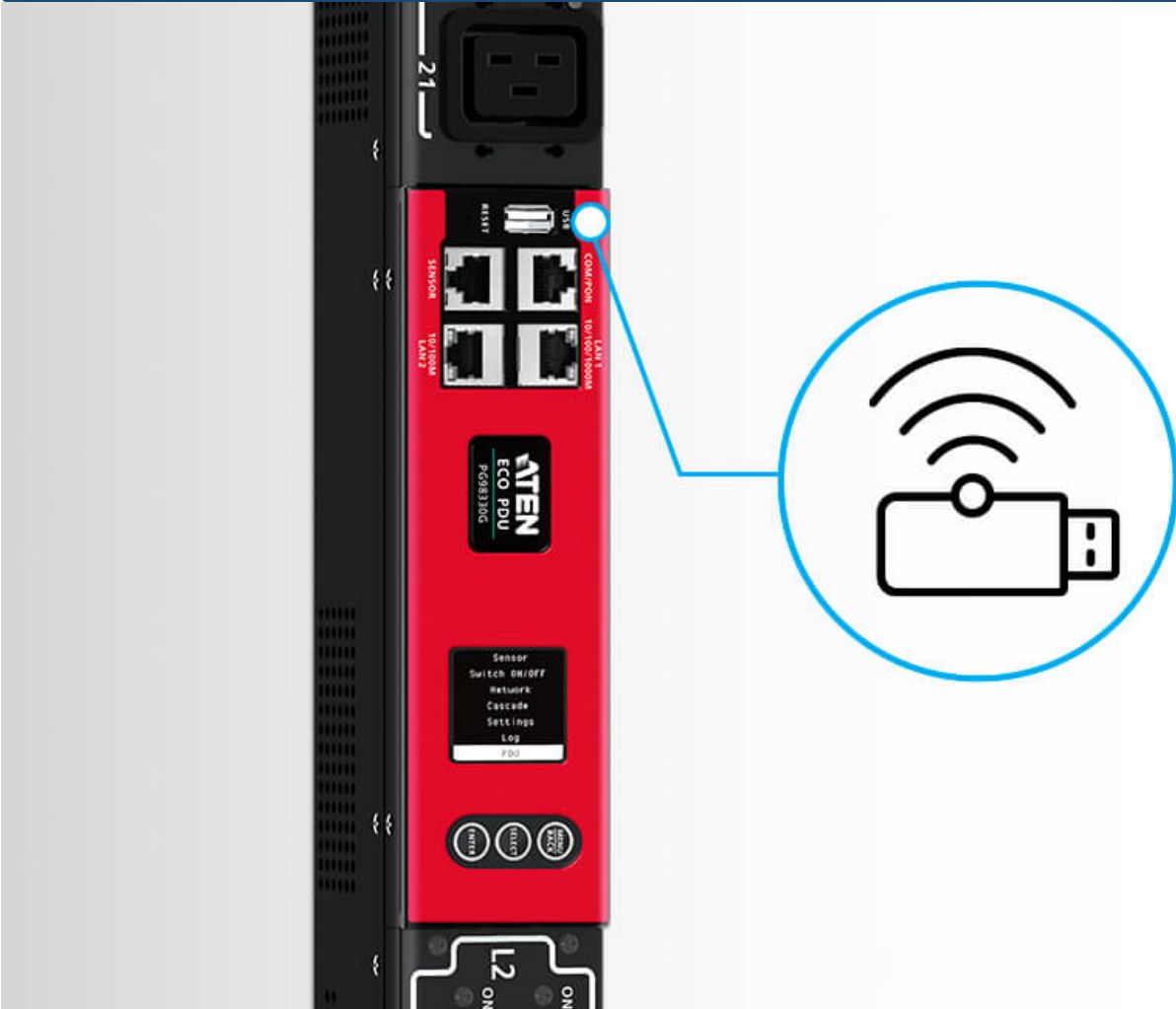

Networkable via WiFi

The PG98330 can be networked via connection to a USB WiFi dongle to perform DCIM, firmware upgrade, log export, quick configuration, and more.

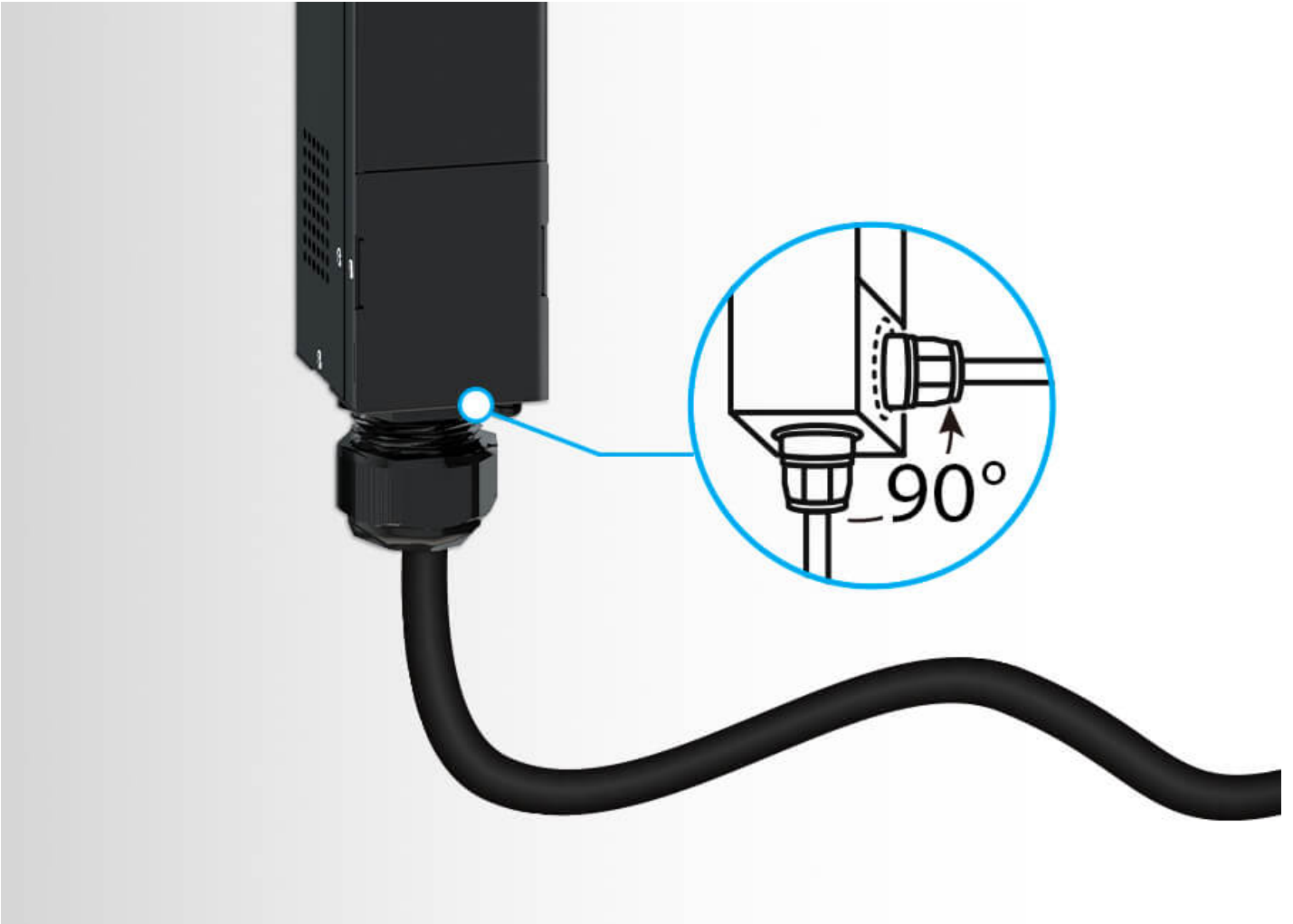

Adjustable Power Cord for Flexible In-Rack Installation

The PG98330 comes with an adjustable power cord built in to the unit capable of 90-degree rotation to allow flexible in-rack installation, resulting in better cable organization.

DCIM Monitoring

Integrated with ATEN's [eco DC](#) – a PC- and web-based tool for optimized Data Center Infrastructure Management (DCIM) – power distribution, energy, and environmental data from PDUs and connected devices can be monitored via a friendly web GUI for smart power management.

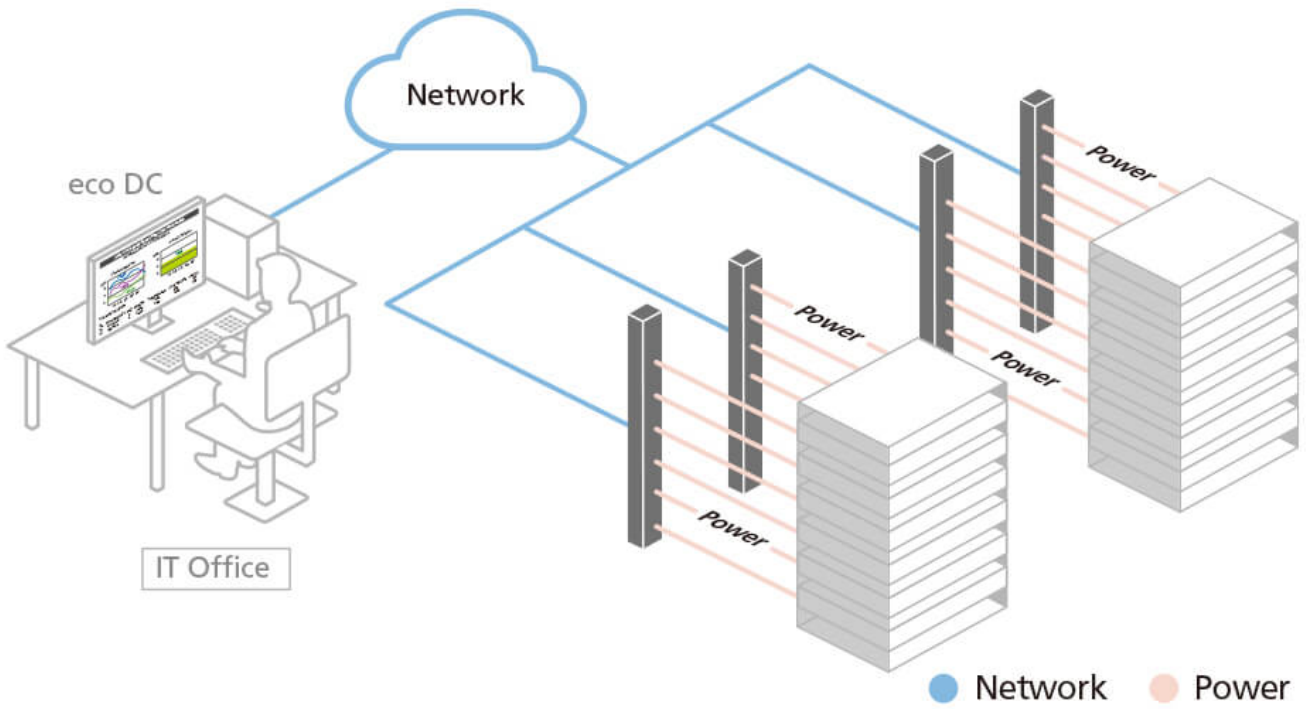

Colored Panel for Smarter Power Monitoring

The PG series PDUs feature a LCD console panel in default red and can be re-colored with options of yellow, purple, blue, and green through optional purchase of colored stickers. These color codes make it easier to differentiate between power feed settings and also speed up troubleshooting in case of unexpected failures.



Applications

The PG series 3-Phase PDUs are perfectly suited to server rack installation requiring energy-efficient power distribution to high-density IT equipment in a server room or data center.



Talk to Our Experts

If you prefer to have ATEN contact you, please complete the form and a representative will be in touch with you shortly

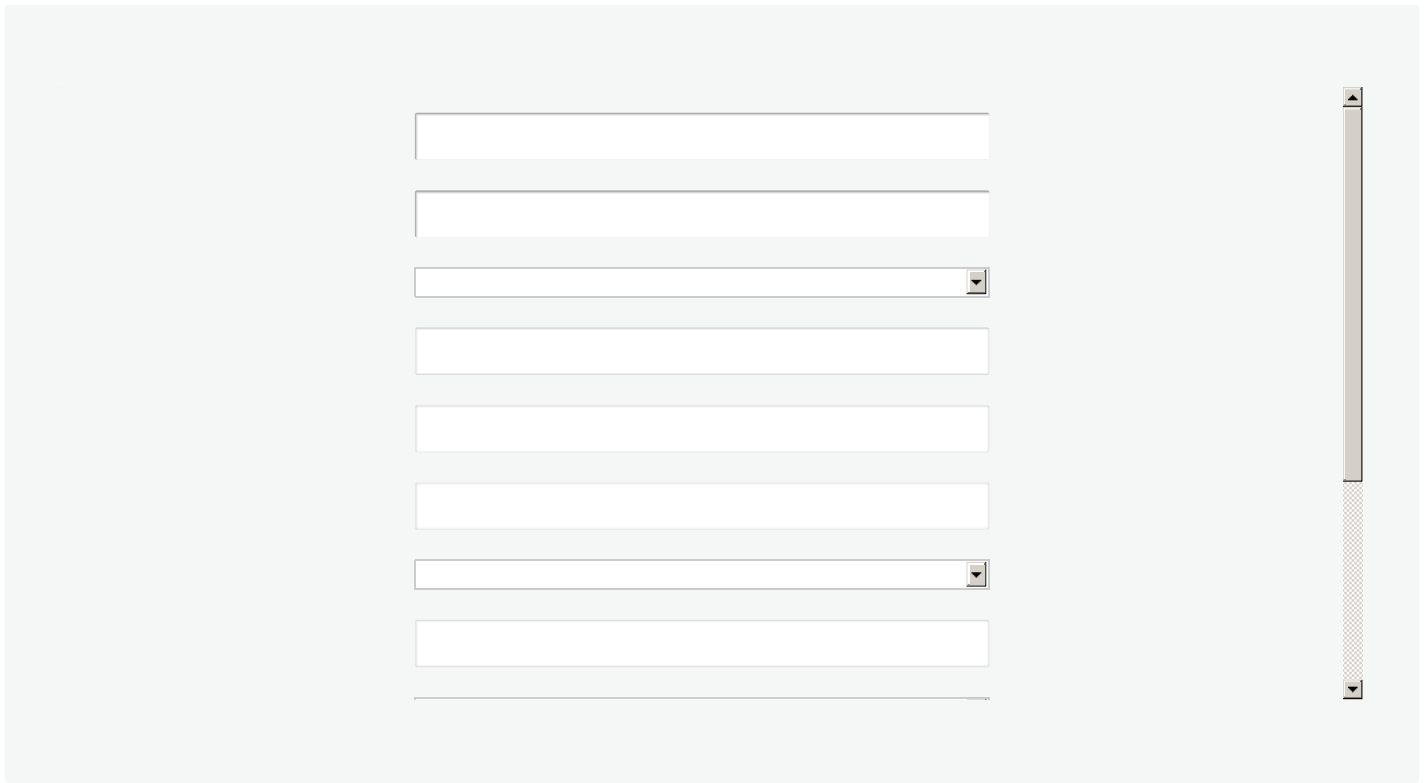

Features

ATEN PG98330 3-Phase Outlet-Metered & Switched eco PDU series contains 6 x IEC 60320 C19 and 24 x IEC 60320 C13 outlets in a 0U rack enclosure. With an ARM Cortex-A8 processor, the PG98330 series delivers flexible control methods through its LAN / COM / USB / environment sensor ports as well as powers up all connected equipment in less than 10 seconds once plugged in. For cost-saving and space-efficient setup purposes, the PG PDUs can be cascaded to connect up to 64 PDU units. As a result, these PDUs accommodate the increasing demand for power to high-density IT devices in server rooms and data centers.

In terms of hardware design, these PDUs have built-in energy-saving relays, a subtype of electromagnetic switch, to help operators control large amounts of current flow, which results in lower energy consumption compared to non-relay models incapable of energy saving.

Other highlights include the circuit breaker preinstalled onto the PG98330 models that support 30A / 32A current flow, which automatically switches off electricity supply to protect devices from overload or damage. With five colors (yellow, red, purple, blue, and green) of LCD console panel stickers available for users to choose from, differentiating between power feed settings and speeding up troubleshooting are made easier. Plus, the LCD console panel is hot-swappable and can be removed, replaced, or repaired without powering down a mission-critical connected load.

Ideal for enterprise servers, network closets, and data centers, the PG series is an intelligent power distribution and management solution that supports high-density IT applications while minimizing the overall cost.

Note: For the list of compatible USB WiFi Network Dongles for PG Series, please refer to the [ATEN Support Center](#) for more information.

- Each PG PDU comes with 6 x IEC 60320 C19 and 24 x IEC 60320 C13 outlets in a 0U rack enclosure
- ARM Cortex-A8 processor for flexible control methods via LAN / COM / USB / environment sensor ports and enhanced monitoring via LCD console
- **Advantageous hardware / network specification**
 - 1 Gbps and 100 Mbps Ethernet ports
 - Auto Ping & Reboot
 - Remote Management Protocols: TCP/IP, UDP, HTTP, HTTPS, SSL, DHCP, SMTP, ARP, NTP, DNS, Auto Sense, Ping, SNMP V1&V2&V3, Telnet, Modbus (over TCP/IP), Wi-Fi, 802.11 a/b/g/n network protocols, and IPv6
 - Alerts / Alarms: receives alarms via SNMP, SMTP, and syslog
 - Scripting: JSON-RPC (Remote Procedure Call) protocol and Python scripting to control specified PDU unit (e.g. Switch On / Off) ¹
 - Security: 2-level account / password login access, and IP / MAC filter, TLS 1.2, SMTP / SMTPS protocols
 - Authentication: LDAP, RADIUS, TACACS+
- **Expandable installation**
 - Allows for connecting up to 64 PDU units with cascading
 - Allows for PON port connection to an ATEN's KN series KVM over IP switch for centralized management of up to 16 cascaded PDUs ²
- Energy-efficient relays allow operators to control large amounts of current flow for lower energy consumption
- Precise kWh metering (+/-1%) for better power consumption habits, baselines, and initiative tracking
- Environment sensor port enables RJ-45 connectivity to connect or daisy-chain up to 8 environment sensors such as ATEN [EA1640](#) for monitoring and management of temperature, humidity, airflow, differential air pressure, and leaks
- Real-time LCD alert sends warnings to alert users of unusual power state
- An adjustable power cord is built in to the unit capable of 90-degree rotation to allow flexible in-rack installation, resulting in better cable organization
- Rotatable LCD Screen – capable of 180-degree rotation, delivering flexible in-rack installation
- Secure locking enhancement prevents power cords from becoming unplugged due to vibration or human error
- Supports ATEN's [eco DC](#) (Energy & DCIM Management Web GUI) for monitoring power distribution, energy, and environmental data from PDUs and connected devices

Note:

1. To be included in a future firmware release.
2. To be included in a future firmware release.

Specifications

Function	PG98330B	PG98330B2	PG98330G
Electrical			
Nominal Input Voltage	208V 3PH (Delta)	208V 3PH (Delta)	400/230V 3PH (Star)
Maximum Input Current	30A Max 24A(UL de-rated)	30A Max 24A(UL de-rated)	32A Max
Input Frequency	50-60 Hz	50-60 Hz	50-60 Hz
Input Connection	NEMA L21-30P	NEMA L15-30P	G Plug: IEC 60309 32A Red 3P+N+E U Plug: Clipsal 32A 56PA532-EO Angled Plug
Input Power	10808VA(Max), 8646VA(UL de-rated)	10808VA(Max), 8646VA(UL de-rated)	22170VA(Max)
Outlet Type	(6) IEC 320 C19, (24) IEC 320C13	(6) IEC 320 C19, (24) IEC 320C13	(6) IEC 320 C19, (24) IEC 320C13
Nominal Output Voltage	208 VAC	208 VAC	230 VAC
Maximum Output Current (Outlet)	C13: 15A(Max),12A(UL derated) C19: 20(Max),16A(UL de-rated)	C13: 15A(Max),12A(UL derated) C19: 20(Max),16A(UL de-rated)	C13:10A(Max), C19:16A(Max),
Breakers	3xUL489(2P)-20A	3xUL489(2P)-20A	6xUL489(1P)-16A
Metering	Outlet level Current, Voltage , PF and KWh Monitoring	Outlet level Current, Voltage , PF and KWh Monitoring	Outlet level Current, Voltage , PF and KWh Monitoring
Outlet Switching	Yes	Yes	Yes
Environment Sensor Ports	Yes	Yes	Yes
Metering Accuracy	1%	1%	1%
Physical Properties			
Dimensions (L x W x H)	179.00 x 5.60 x 6.80 cm (70.47 x 2.2 x 2.68 in.)	179.00 x 5.60 x 6.80 cm (70.47 x 2.2 x 2.68 in.)	179.00 x 5.60 x 6.80 cm (70.47 x 2.2 x 2.68 in.)
Weight	8.43 kg (18.57 lb)	8.43 kg (18.57 lb)	8.43 kg (18.57 lb)
Power Cord Length	3m	3m	3m
Environmental			
Temperature (Operating / Storage)	0 – 60°C / -20 – 60°C	0 – 60°C / -20 – 60°C	0 – 60°C / -20 – 60°C
Humidity (Operating & Storage)	0 – 80% RH, Non-Condensing	0 – 80% RH, Non-Condensing	0 – 80% RH, Non-Condensing
Compliance			
EMC Verification	FCC	FCC	CE, EMC
Safety Verification	UL, PSE	UL, PSE	CE, UL, PSE
Warranty	3 years	3 years	3 years
Note	For some of rack mount products, please note that the standard physical dimensions of WxDxH are expressed using a LxWxH format.		

Diagram

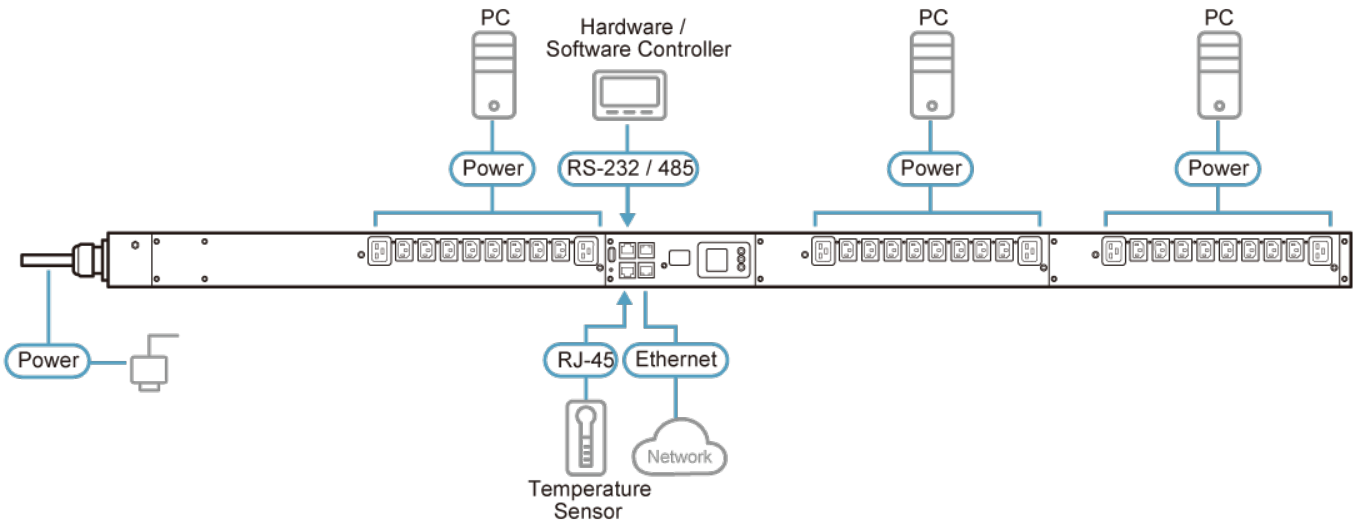

Note: As there are many PG PDUs, PG98230G is the example used here.
