

VW1608

16 x 8 Modular Video Wall Processor



**High-Motion Visuals,
Flexible Multi-View Control**

4K TRUE 16x08 / 36x20
Modular Video Wall Processor

VW3620 **VW1608**

iF DESIGN AWARD 2024 **reddot winner 2024** **GOOD DESIGN AWARD 2023**

The future of video wall control starts here!



Video Wall Processor for Demanding Environments

The VW1608 is a modular 4K video wall processor that manages 16 input sources and 8 displays from a compact 4U chassis. It delivers stunning visual clarity, intelligent control and monitoring, high scalability, and rock-solid reliability – ideal for war rooms, control centers, auditoriums, and digital signage applications.

Precision Visual Performance

True-to-Life Visual Fidelity

The VW1608 delivers true 4K60 4:4:4, presenting every source with crystal-clear detail and accurate color. Its FPGA-based hardware architecture and FrameSync technology ensures tear-free, latency-free visuals even during rapid source switching.

Optimized for Any Display Environment

The processor upscales and optimizes content for any display type and size, ensuring every pixel delivers maximum clarity across video walls.



ATEN's FrameSync



**Without
ATEN's FrameSync**



Maximize Screen Efficiency and See More at Once

Flexible Multi-Window Control for Higher Productivity

Optimizes screen space with flexible window layouts, including overlapping, picture-by-picture and picture-in-picture. The VW1608 supports up to four canvases on a video wall, each with independent sources, resolutions, and layouts – ideal for tailored, dynamic displays.

Pixel-Perfect Cropping for Focused Visuals

Video content can be cropped at the pixel level to highlight key details for a more engaging viewing experience.

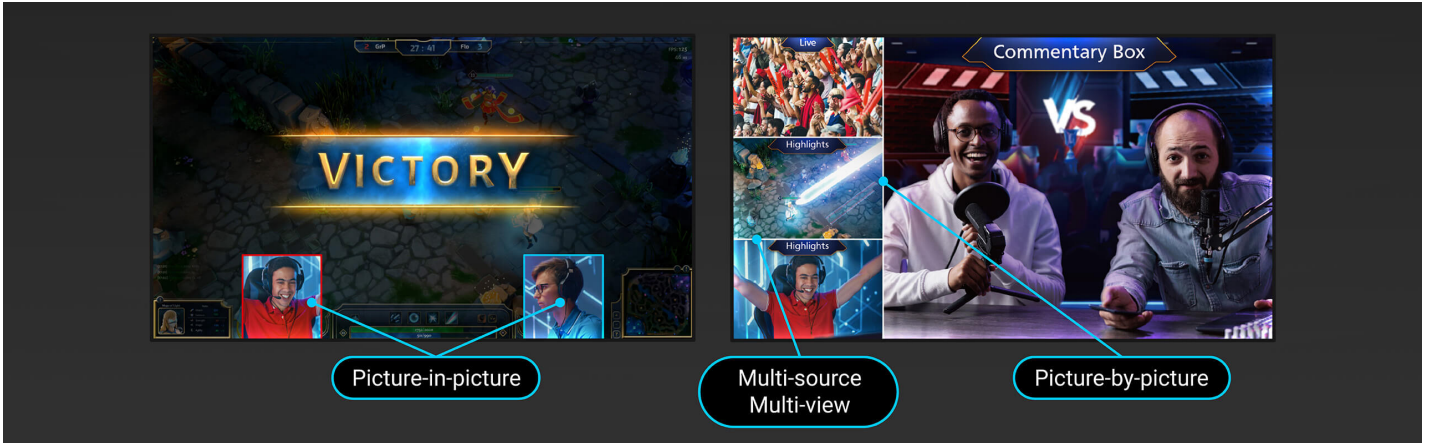

Picture-in-picture

Multi-source Multi-view

Picture-by-picture

Scalable Architecture that Grows with You

Modular Design for Effortless Expansion

The VW1608's 4U chassis features 4 input and 2 output board slots, supporting 16 sources and 8 displays, with a modular design for easy upgrades. The redundant power modules and a hot-swappable cooling fan module ensure maximum uptime.

Scalable to 24 Displays with Daisy-Chain Integration

The VW1608 offers exceptional scalability and failover via daisy-chaining, enabling up to three units to be linked for a total of 24 display outputs. This design protects your investment and adapts to projects of any size.



CPU Board Slot

Local User Console

Input Board Slots x 4

Output Board Slots x 2

Power Board Slot

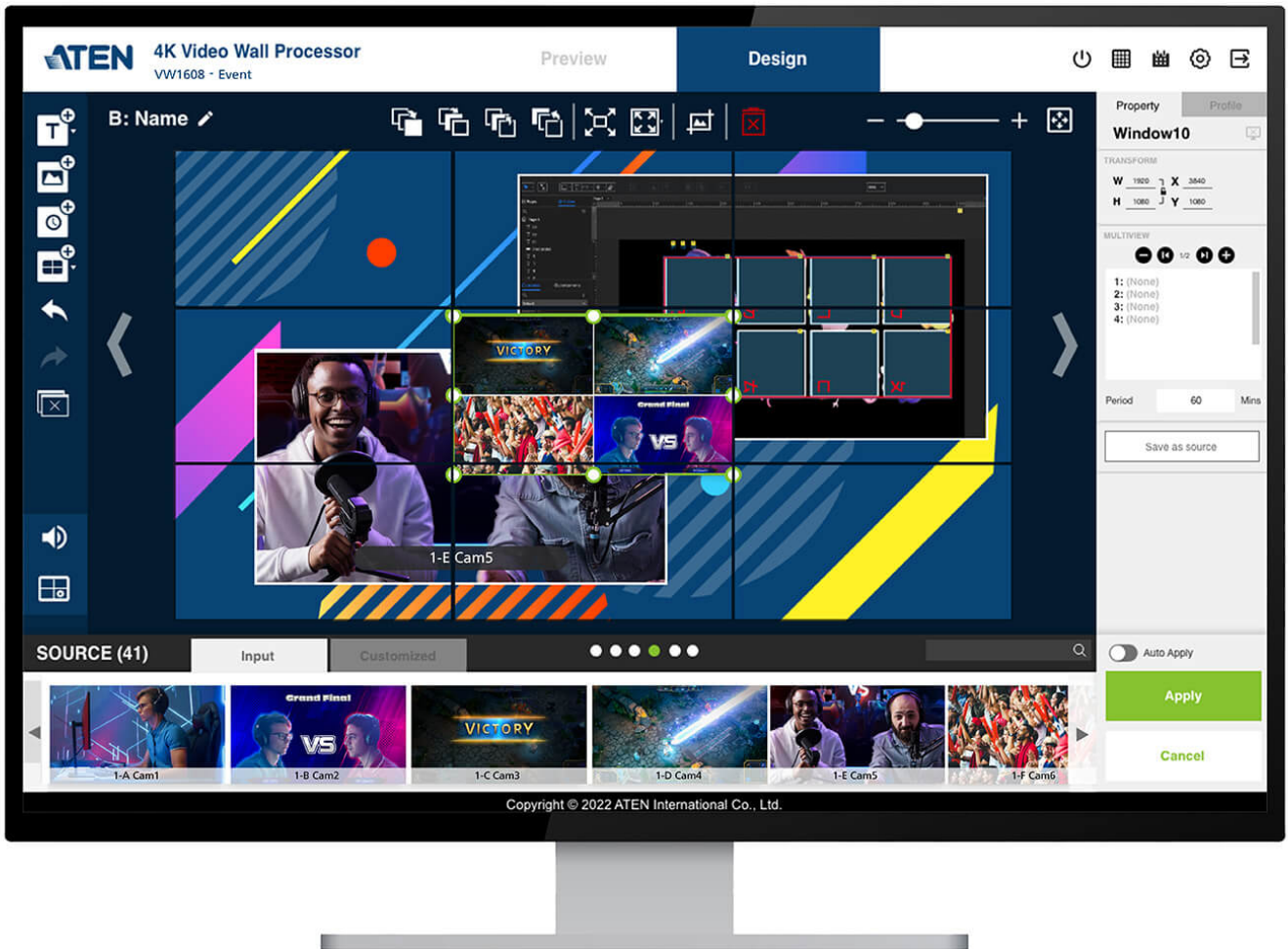

Seamless Control

Remote and Local Previews for Intuitive Control

The Web GUI enables real-time drag-and-drop layout control, while the local HDMI output provides live previews to verify adjustments – such as repositioning a feed or adding an overlay – before going live.

Seamless Integration for Streamlined Operations

Integration with third-party control platforms via RESTful API, Telnet, and RS-232, VW1608 delivers an intelligent and simplified control experience.

Mission-Critical Reliability

Redundant Architecture for Continuous Uptime

Deploy two VW1608 units to create a high-availability cluster, featuring real-time mirroring and automatic failover that keeps your video wall running even if the primary unit becomes unavailable. With built-in redundancy, hot-swappable modules, the VW1608 ensures continuous operation.

Auto-Backup Protection for Mission-Critical Stability

Automatic configuration backup and recovery protect against system or network failures, keeping mission-critical environments running smoothly 24/7.

Applications

War Room

For war room applications, the VW1608 enables multi-source visualization, flexible multi-window layouts, multi-canvas dashboards, and redundancy, enabling operators to monitor live feeds, highlight critical information, and maintain uninterrupted situational awareness.

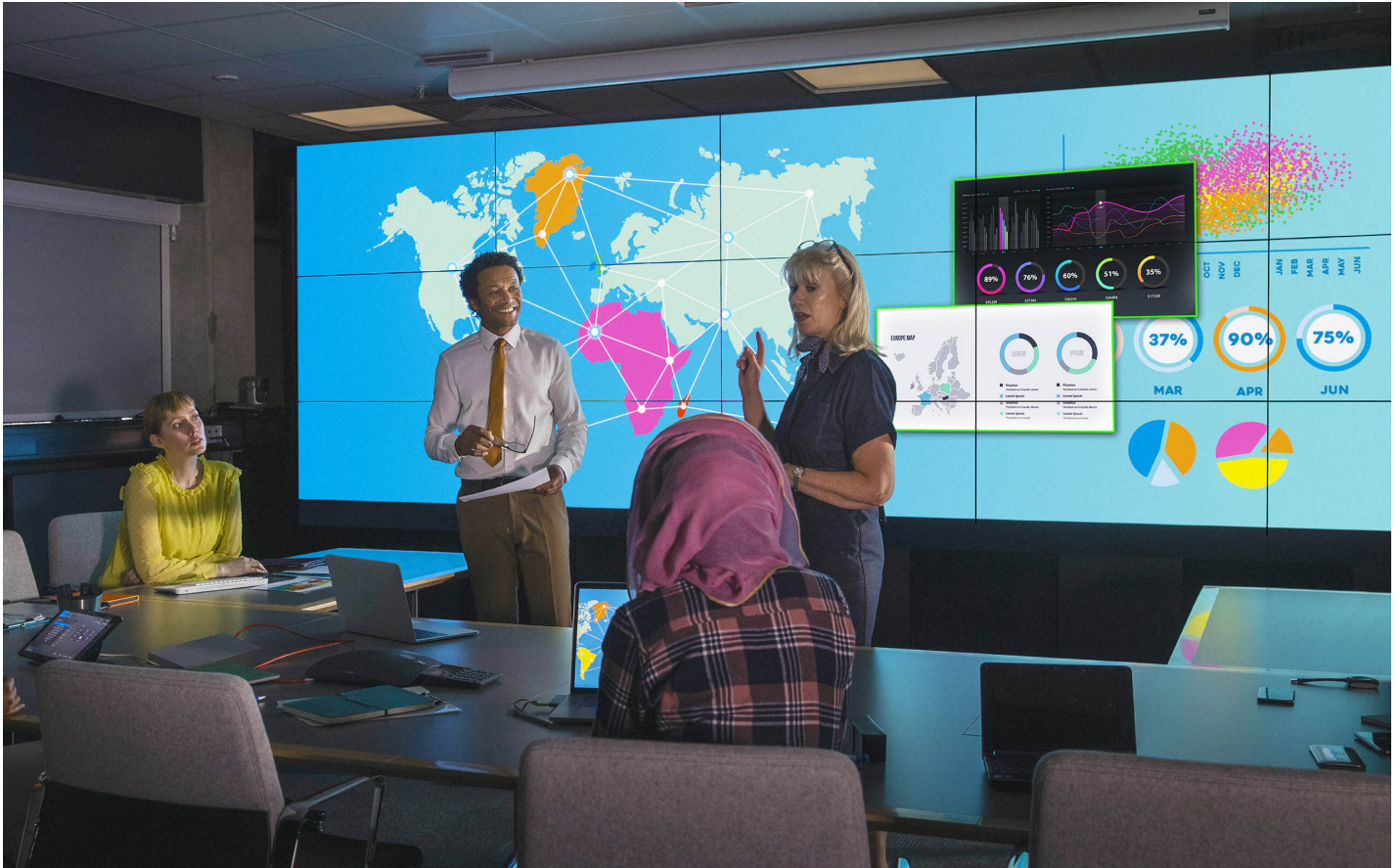



Control Room / Surveillance Room

For control room scenarios, the VW1608 provides real-time 4K multi-source switching, flexible multi-window management, four-canvas information integration, and redundancy, ensuring smooth display of multiple sources, controllable key visuals, and uninterrupted 24/7 operation.

Auditorium

For auditoriums, the VW1608 delivers high-resolution multimedia output, flexible window layouts, real-time cropping and overlay display, ensuring clear and impactful performance and presentations on large screens while managing multiple audio-visual sources simultaneously.



Talk to Our Experts

If you prefer to have ATEN contact you, please complete the form and a representative will be in touch with you shortly

First Name *

Last Name *

- Country *

Company *

Email *

Phone Number *

- Customer Type *

Job Title *



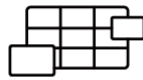

Independent Canvases

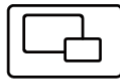

Overlay Window Management



Pixel-perfect Cropping

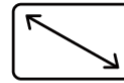

Diverse LED Display Compatibility

Features

• **4U modular chassis with ample slot amount for system control and expansion**

- Accepts up to 16 HDMI input ports and 8 HDMI output ports
- Compact, yet competent for LED video walls in small-to-medium sized mission-critical environments
- Modular board compatibility – Contains 7 board slots (4 input card slots, 2 output card slots, and 1 CPU board slot) to support multiple I/O boards for flexible configuration and future expandability

• **Superior Visual Quality for Mission-Critical Communications**

- FPGA architecture – supports True 4K inputs, near-zero-second seamless source switching, and outputs without delay
- True 4K@60Hz (4:4:4) scalability – supports custom resolutions and enables upscaling of video signals for crystal clear, accurate imagery regardless of the display size or type from LED, LCD, DLP, to other large screens
- Decodes high density H.265 / H.264 IP channels (via [VW754](#)) – ideal for surveillance control rooms and real-time monitoring scenarios
- Advanced video wall engine – allows easy window management via cropping, overlapping, picture-by-picture, picture-in-picture, bezel compensation, and more
- Multi-resolution support – allows mix-and-match of displays of different resolutions
- FrameSync – ensures that all output signals remain synchronized to prevent image tearing and frame mismatch, providing seamless playback across multiple displays
- EDID Expert™ – selects optimum EDID settings for smooth power-up, high quality display and use of the best video resolution across different screens
- Customizable logos / color schemes / calendar / clock / scrolling texts

• **Reliable 24/7 Operation**

- Backup Mode 2x VW1608s daisy chain – the secondary unit continuously mirrors all system settings and configurations from a primary one in real time and takes control automatically when primary unit malfunction occurs for uninterrupted display performance
- Expansion Mode with 3x VW1608s daisy chain – up to 24 display outputs supported for larger video wall installation with centralized control being conducted by the primary unit while ensuring synchronized video output clocks across all units and consistent, frame-accurate playback without tearing
- Optimum component redundancy via a hot-standby CPU control board, dual redundant power boards (2 slots), and hot-swappable I/O boards as well as fan module

• **Direct and Remote Configurations and Control Methods**

- Direct control via RS-232 / Ethernet and the front panel buttons
- Local HDMI output – monitor input signals and video wall layouts via Single / Array mode at up to 1080p in real-time from one display
- Remote control via web GUI, Telnet, and SSH to preview input signals in real-time and control outputs including content placement and management of up to 4 canvases
- Multiview – source monitoring in 2 x 2 or 4 x 4 layouts from a single display
- Integration with ATEN Control System and the 3rd party devices via RS 232 / Ethernet / RESTful API
- Built-in USB Type-A ports – video wall background image change and firmware upgrade

Specifications

Board Input	4 x Slot, up to 16 4K inputs (Note: top 2 Slots can be used for Function Board)
Board Output	2 x Slot, up to 8 True 4K outputs
Video Input	
Interfaces	Depends on which I/O board is inserted
Video Output	
Interfaces	Local Output: 1x HDMI Type A Female (Black)
Control	
RS-232	Connector: 1 x DB-9 Female (Black) Serial Control Pin Configurations: Pin2 = Tx, Pin 3=Rx, Pin 5= Gnd Baud Rate and Protocol: Baud Rate:19200, Data Bits:8, Stop Bits:1, Parity: No, Flow Control: No
Ethernet	Connector: 1 x RJ-45 Female
USB	3 x USB Type A Female (White) Note: Currently the USB ports support storage and firmware upgrade.
EDID Settings	EDID Mode: Default / Port1 / Remix / Customized (EDID Wizard support)
Communication	
Daisy Chain Ports	RJ45 x2
Connectors	
Power	1 x 3-Prong AC Socket
Power (Optional)	Redundancy, Optional Hot Swap PSU
Power	
Maximum Input Power Rating	100-240 VAC; 50-60Hz; 10A
Power Consumption	AC110V:550W:326BTU/h AC220V:550W:324BTU/h Note: <ul style="list-style-type: none"> • The measurement in Watts indicates the typical power consumption of the device with no external loading. • The measurement in BTU/h indicates the power consumption of the device when it is fully loaded.
Environmental	
Operating Temperature	0 - 40°C
Storage Temperature	-20 - 60°C
Humidity	0 - 80% RH, Non-Condensing
Physical Properties	
Housing	Metal
Dimensions (L x W x H)	48.20 x 46.61 x 17.67 cm (18.98 x 18.35 x 6.96 in.)
Weight	11.65 kg (25.66 lb)
Rack Height (U Spaces)	4U
Carton Lot	1 pc
Note	For some of rack mount products, please note that the standard physical dimensions of WxDxH are expressed using a LxWxH format.

Diagram

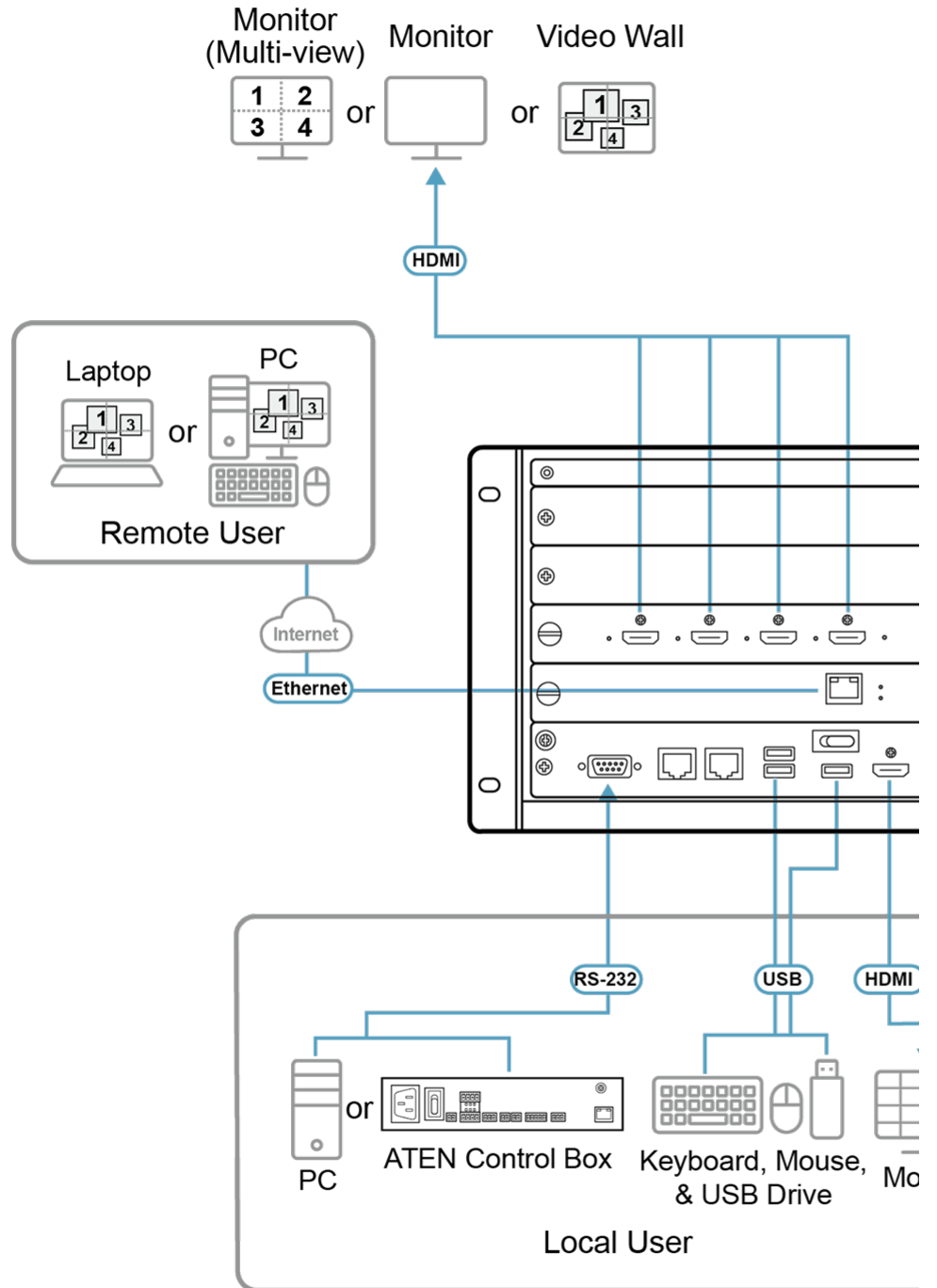



Simply Better Connections

ATEN International Co., Ltd.

3F., No.125, Sec. 2, Datong Rd., Sijhih District., New Taipei City 221, Taiwan
Phone: 886-2-8692-6789 Fax: 886-2-8692-6767
www.aten.com E-mail: marketing@aten.com



© Copyright 2015 ATEN® International Co., Ltd.
ATEN and the ATEN logo are trademarks of ATEN International Co., Ltd.
All rights reserved. All other trademarks are the property of their
respective owners.