

## CS19216

16-Port USB 3.0 4K DisplayPort KVM Switch



# Streamline Server Management with 4K USB 3.0 Rack KVM Efficiency

CS18208 / CS18216  
CS19208 / CS19216 ▶



Maintaining effective IT operations is crucial to keeping businesses and services running. With workforces navigating the adjustments of the new normal, sustaining 24/7 uninterrupted IT services while remaining competitive has become more mission-critical than ever. Meanwhile, as the amount of data has continued to grow exponentially over the years, boosting operational efficiency remains the focal point for data center and server room professionals as they strive to streamline routine procedures in automated processes, such as data entry, feature testing, BIOS flash, system updates, and much more.

The CS19216, featuring superior 4K video quality, USB 3.0 peripheral agility, and space-saving rackmount capability, allows 16 computers to be centrally controlled via a single console where IT engineers are enabled to expedite system operations by configuring multiple units simultaneously instead of working one at a time; routine or repetitive tasks and procedures can be promptly replicated and broadcasted on multiple computers in seconds, slashing time, space, and cost, while pursuing strengthened enterprise productivity.



Superior Visual Clarity



Video DynaSync™

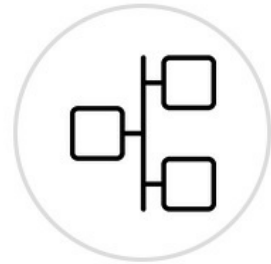

Scalability



Multi-Display Setup



Multiplatform Support



USB 3.0 Peripheral

**Spectacular 4K DCI Visual Performance**

With connection to HDMI or DisplayPort-enabled computers, 4K USB 3.0 Rack KVM Switch series effortlessly enriches console desktop operations with up to 4K DCI (4096 x 2160 @60 Hz) visual excellence. Video sources of high resolution visuals and imaging are displayed with great precision for improved analysis.



**Video DynaSync™**

Empowered by patented ATEN technology – Video DynaSync™, Rack KVM Switches deliver a smooth viewing experience by maintaining the ideal video settings under all operating systems when switching between ports, speeding up switching between systems, and powering up uninterruptedly while eliminating boot-up display problems.

**without Video DynaSync™**



After port switching...

**with Video DynaSync™**

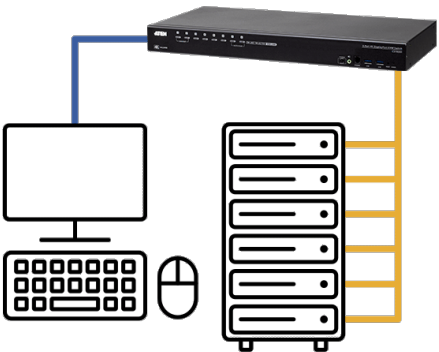

**Broadcast Mode to Expedite Timely Configurations**

The practical and efficient Broadcast Mode can be easily invoked via OSD or serial commands to perform the same task or command simultaneously on all connected computers across different OS platforms, including software installation and upgrading, function testing, BIOS flash update, system-wide shutdown, and more, making server management effortless and hassle-free.



**Cascadability to Upscale Server Management Efficiency**

The number of connected computers can be scaled up to 128 by cascading the [CS19208](#) in 1st level and the CS19216 in 2nd level (or the CS19216 in 1st level and the [CS19208](#) in 2nd level), leaving room and flexibility for network expansion when needed.

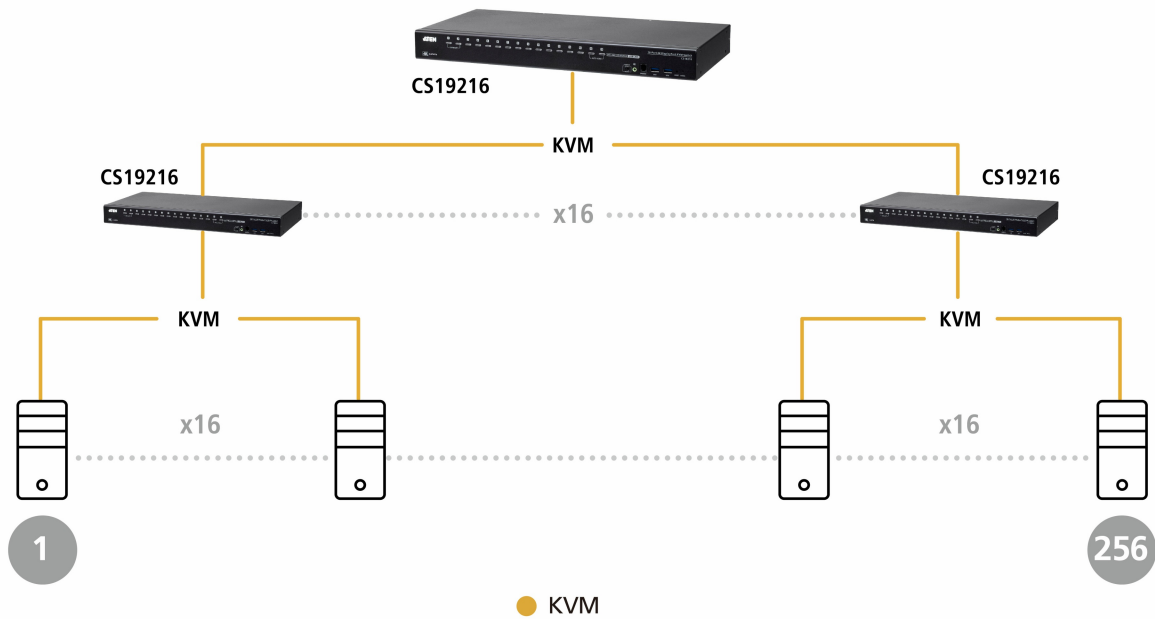

**Resilient Multi-Display Setup to Facilitate Live Feeds**

When a large amount of complex content needs to be viewed at once or there's a need to examine intensive data for analysis, up to 8 Rack KVM Switches can be stacked up to allow up to 8 monitors to be set up in a multi-display configuration (such as dual- / triple- / quad-display) to facilitate live feeds among computers at the console desktop.

## Quad-Display Setting

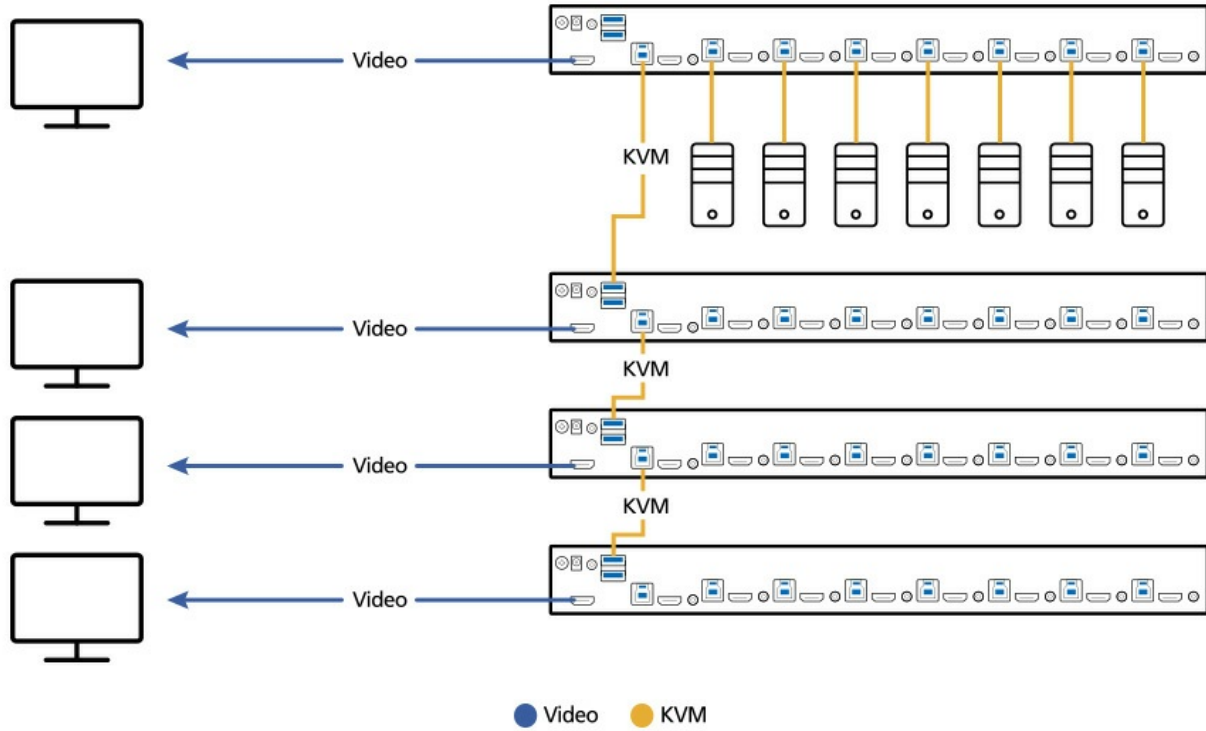

### Contact Us

Get a quote for this product or get in touch with our sales experts

[Get Quote](#)

[Contact Sales](#)

#### Superb Data Transfer Rate for Swift Peripheral Sharing

The built-in 2-port USB 3.1 Gen 1 hub supports plug-n-play connection to two peripheral devices (e.g., printer, scanner, flash drive, etc.) for high-speed data transmission of up to 5 Gbps transfer rate, making console desktop operations agile and efficient.



**Flexible Port-Switching Methods for Uplifted Productivity**

Port switching is as easy and convenient as pressing the front-panel pushbuttons, pressing supported hotkeys, using the OSD, or entering RS-232 commands, whichever works best for you.



Hotkey

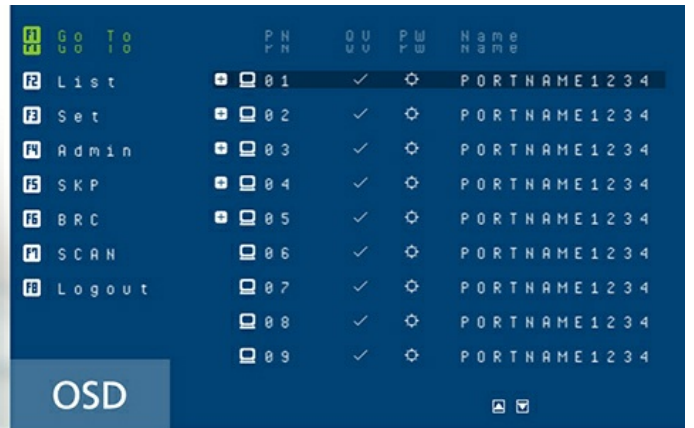

OSD



Pushbutton

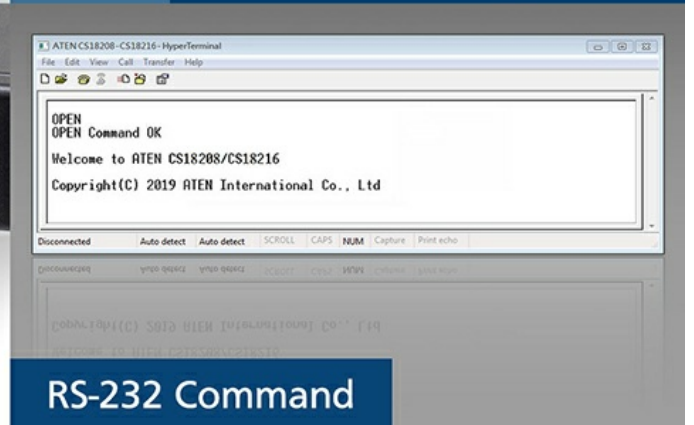

RS-232 Command

**Space-Efficient 2-in-1U Rack Mounting**

The ATEN 2-in-1U Mounting Kit (model: [2K-0001](#) / [2K-0002](#)) enables the housing of an ATEN Rack KVM Switch with an ATEN Ultra Short Depth LCD Console in a 1U rack space, facilitating rack installation with optimum space efficiency.



**Applications**



## Sever Room Management



## Production Line Automation

Product Comparison

### Talk to Our Experts

If you prefer to have ATEN contact you, please complete the form and a representative will be in touch with you shortly



Specifications

Computer Connections	
Direct	16
Maximum	256 (via Cascade)
Port Selection	OSD, Hotkey, Pushbutton, RS-232Commands
Connectors	
Console Ports	1 x DisplayPort Female 1 x HDMI Female (Black) 2 x USB Type A Female 2 x 3.5mm Audio Jack Female (Green; 1 x front, 1 x rear)
KVM Ports	16 x DisplayPort Female 16 x USB3.1 Gen1 Type B Female (Blue) 16 x 3.5mm Audio Jack Female (Green)
Firmware Upgrade	1 x RJ11 Female (Black)
Power	1 x DC Jack
USB Hub	2 x USB3.1 Gen1 Type A Female (Blue; 2 x front)
Switches	
Port Selection	16 x Pushbutton
Reset	1 x Semi-recessed Pushbutton
Firmware Upgrade Recovery	1 x Slide Switch
LEDs	
On Line /Selected	16 (Orange)
Power	1 (Green)
USB Link	16 (Green)
Emulation	
Keyboard / Mouse	USB
Video	DisplayPort: 4096 x 2160 @ 60Hz; HDMI: 4096 x 2160 @ 60Hz
Scan Interval	0 – 255 seconds (default: 5 secs.)
Power Consumption	DC12V:26.66W:175BTU/h  Note: ● The measurement in Watts indicates the typical power consumption of the device with no external loading. ● The measurement in BTU/h indicates the power consumption of the device when it is fully loaded.
Environmental	
Operating Temperature	0 – 40°C
Storage Temperature	-20 – 60°C
Humidity	0 – 80% RH, Non-condensing
Physical Properties	
Housing	Metal
Weight	3.54 kg ( 7.8 lb )
Dimensions (L x W x H)	43.24 x 21.43 x 4.40 cm (17.02 x 8.44 x 1.73 in.)
Note	For some of rack mount products, please note that the standard physical dimensions of WxDxH are expressed using a LxWxH format.

Diagram

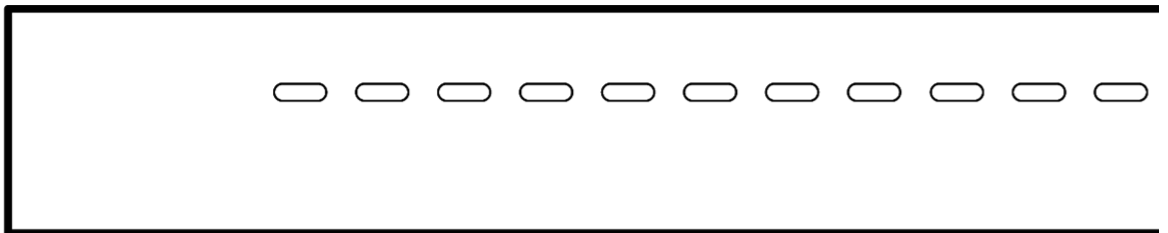

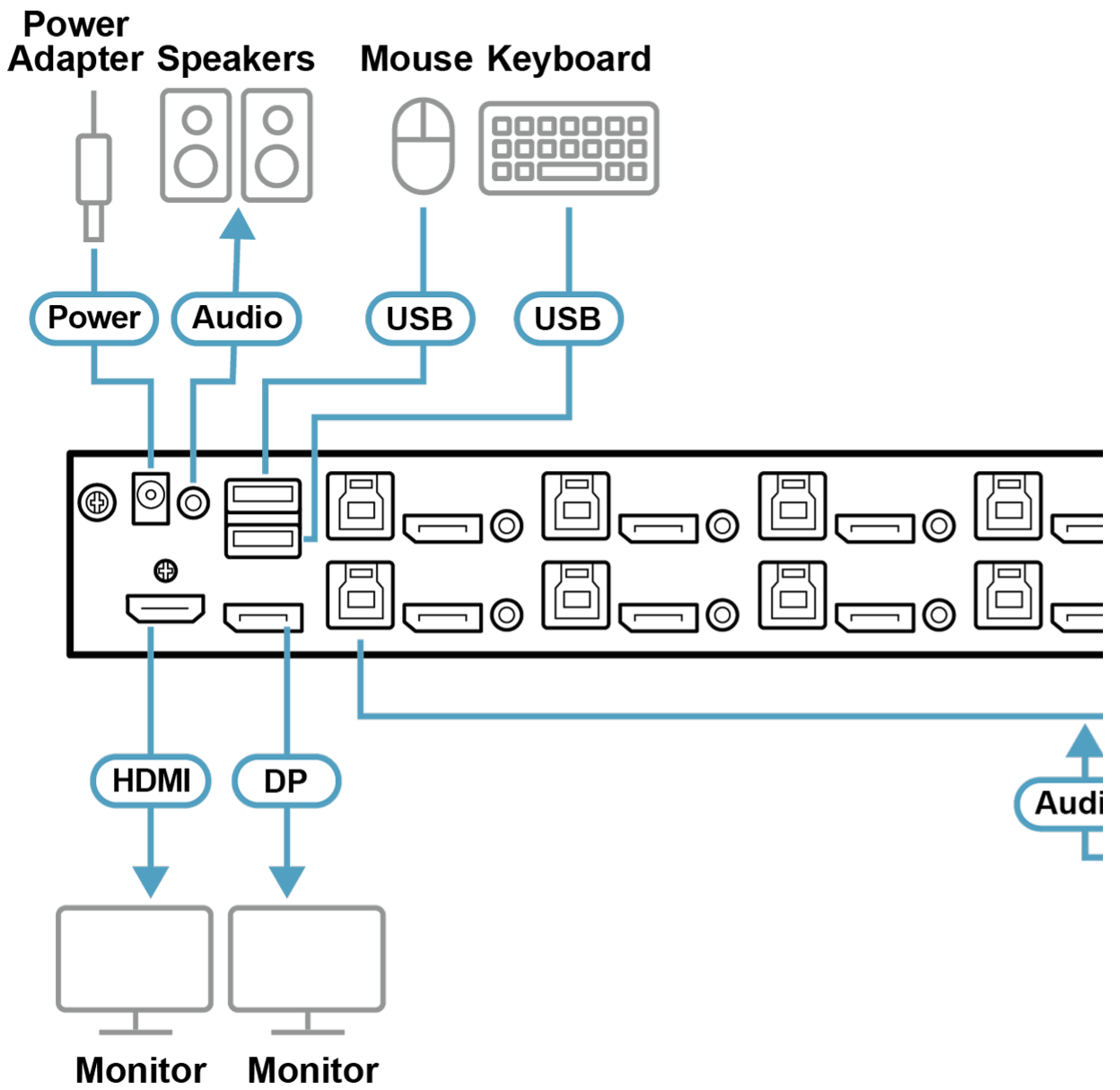



Simply Better Connections

**ATEN International Co., Ltd.**

3F., No.125, Sec. 2, Datong Rd., Sijhih District., New Taipei City 221, Taiwan  
Phone: 886-2-8692-6789 Fax: 886-2-8692-6767  
www.aten.com E-mail: marketing@aten.com



© Copyright 2015 ATEN® International Co., Ltd.  
ATEN and the ATEN logo are trademarks of ATEN International Co., Ltd.  
All rights reserved. All other trademarks are the property of their  
respective owners.